



Biotechnology Explorer™

**Crime Scene Investigator
PCR Basics™ Kit**

Catalog #166-2600EDU

explorer.bio-rad.com

Note: Kit contains temperature-sensitive reagents. Open immediately upon arrival and store components at -20°C or at 4°C as indicated.

Duplication of any part of this document is permitted for classroom use only.

Please visit explorer.bio-rad.com to access our selection of language translations for Biotechnology Explorer kit curricula.



Crime Scene Investigator PCR Basics Kit

This curriculum was developed in collaboration with Dr. Linda Strausbaugh, Director of the Center for Applied Genetics and Technology at the University of Connecticut-Storrs. This Crime Scene Investigator PCR Basics™ kit allows students to conduct state-of-the-art DNA profiling techniques and to develop an understanding of how these techniques are performed in real-world forensic science labs. Bio-Rad is grateful for Dr. Strausbaugh's guidance and mentorship.

How can DNA evidence solve crimes? DNA profiling is the use of molecular genetic methods to determine the exact genotype of a DNA sample to distinguish one human being from another. This powerful tool is now routinely used around the world for investigations of crime scenes, missing persons, mass disasters, human rights violations, and paternity testing. Crime scenes often contain biological evidence (such as blood, semen, hairs, saliva, bones, pieces of skin) from which DNA can be extracted. If the DNA profile obtained from evidence discovered at the scene of a crime matches the DNA profile of a suspect, the individual is included as a potentially guilty person; if the two DNA profiles do not match, the individual is excluded from the suspect pool.

What kinds of human DNA sequences are used in crime scene investigations? There are ~3 billion bases in the human genetic blueprint – greater than 99.5% do not vary among human beings. However, a small percentage of the human DNA sequence (<0.5%) does differ, and these are the **polymorphic** ("many forms") sequences used in forensic applications. By universal agreement, the DNA sequences used for forensic typing are "anonymous"; that is, they are derived from regions of our chromosomes (also called **loci**) that do not control any known traits and have no known functions.

The DNA sequences used in forensic DNA profiling are non-coding regions that contain segments of **short tandem repeats** or **STRs**. STRs are very short DNA sequences that are repeated in direct head-to-tail fashion. The example below (Figure 1) shows a locus known as TH01) actually used in forensic DNA profiling; the DNA sequence at this locus contains four repeats of [TCAT].

..CCCTCATTTCATTTCATTTCATTCA..

For the TH01 STR locus, there are many alternate polymorphic forms (**alleles**) that differ from each other by the number of [TCAT] repeats present in the sequence. Although more than 20 different alleles of TH01 have been discovered in people worldwide, each of us still has only two of these, one inherited from our mother and one inherited from our father.

Suspect A's DNA type for the TH01 locus is (5–3) Suspect B's DNA type for TH01 locus is (6–10)
C C C □ □ □ □ □ A A A 5* C C C □ □ □ □ □ □ □ A A A 6*
C C C □ □ □ A A A 3* C C C □ □ □ □ □ □ □ □ □ □ □ A A A 10*

* Number of [TCAT] repeats

Fig. 1. Two sample genotypes at the TH01 locus.

How are STR alleles detected? The key to DNA profiling is amplification of the copies present in the small amounts of evidentiary DNA by **polymerase chain reaction (PCR)**. Using primers specific to the DNA sequences on either side of the STR, billions of copies of each of the two original TH01 alleles in any one person's DNA type are synthesized in the reaction. These copies contain the same number of STRs present in the original DNA copies and can be separated by size using agarose gel electrophoresis. By comparison with size standards that correspond to the known sizes of TH01 alleles, the sizes of the amplified copies can be determined.

This kit allows students to simulate genotyping at a locus as commonly used in forensic typing. In real crime scene applications, DNA profiling is performed at a number of different loci to improve the **power of discrimination** of the testing. In simple terms, the power of discrimination is the ability of the typing to discriminate between different individuals. As an example, one locus may be able to tell the difference between one out of 1,000 people, whereas two loci can discriminate between one out of 10,000 people. The larger the number of loci typed, the more powerful the ability to discriminate.

Following the DNA profiling at the simulated BXP007 locus in the Crime Scene Investigator PCR Basics kit, the teacher has the option of an additional lesson that simulates the use of the 13 core CODIS (Combined DNA Index System) loci used in actual casework. This simple exercise demonstrates the concept of increasing power of discrimination with increasing numbers of loci typed, and illustrates how even siblings can be identified by DNA profiling. Each student team will generate their own set of genotypes, collect and record data on a worksheet, and perform simple statistical calculations.

Teaching Strategy – Guided Inquiry-Based Investigation

The intent of this curriculum is to guide students through the thought process involved in a laboratory-based scientific investigation. Students will learn about PCR, gel electrophoresis, genotyping, and genotype matching while asking the question "How can a tiny amount of genetic material (DNA) be used to identify one person out of a billion?" In the context of a crime scene case study scenario, this activity could raise a host of questions such as "Why is this important?"

The students' focus is not so much on the answer or result, but on how the result was obtained and substantiated by careful observation and analysis of their data. Students who engage in Biotechnology Explorer activities develop a positive sense of their ability to employ the scientific method to solve problems. Thought provoking questions embedded in the student manual are designed to maximize students' involvement in the laboratory. Student involvement in this process results in an increased understanding of the value of approaching a scientific challenge in an organized and logical fashion.

This manual can be downloaded from the Biotechnology Explorer website. Visit us on the web at explorer.bio-rad.com, or call us in the US at 1-800-4BIORAD (1-800-424-6723).

We continually strive to evolve and improve our curricula and products. We welcome your suggestions and ideas!

Ron Mardigian
Founder
Biotechnology Explorer Program
Bio-Rad Laboratories

Create context. Reinforce learning. Stay current.

New scientific discoveries and technologies create more content for you to teach, but not more time. Biotechnology Explorer kits help you teach more effectively by integrating multiple core content subjects into a single lab. Connect concepts with techniques and put them into context with real-world scenarios.

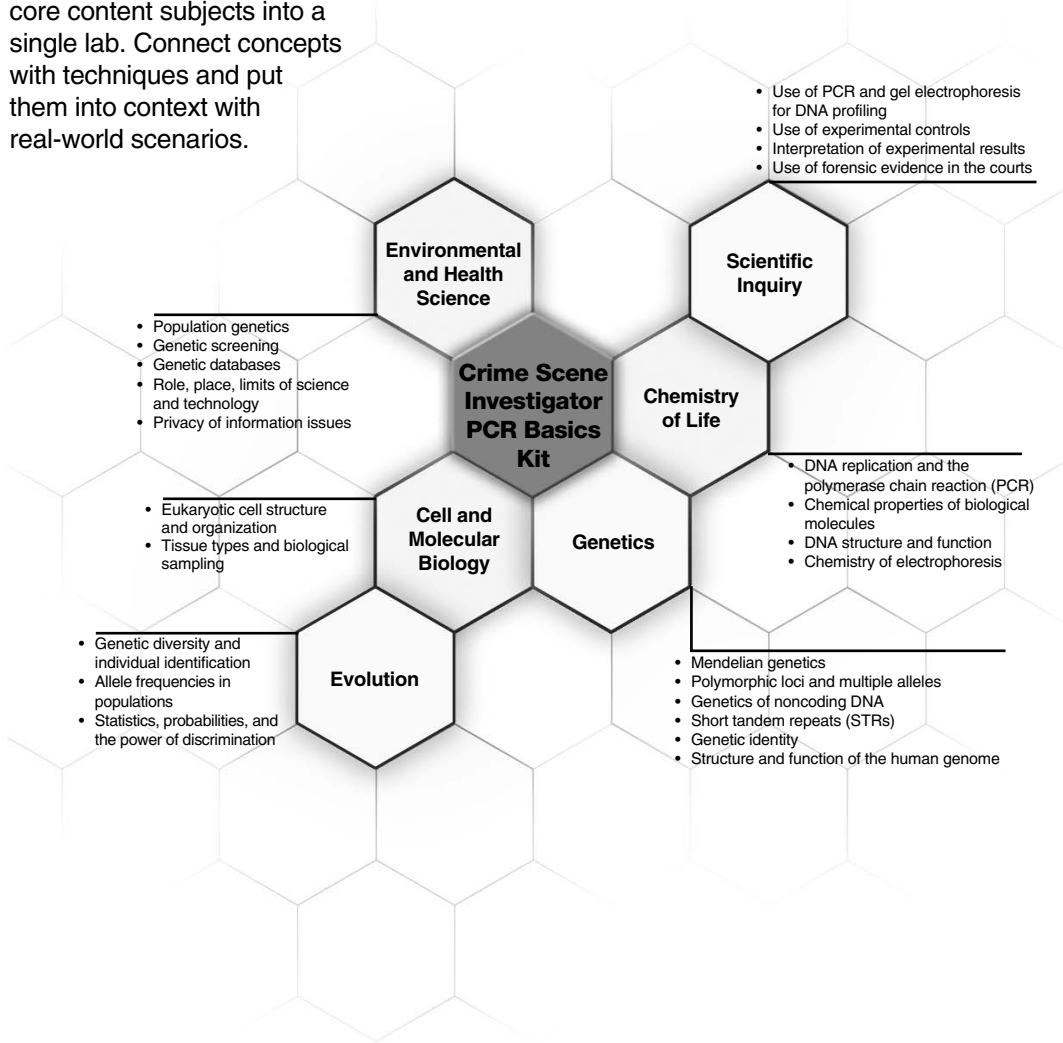

Table of Contents

	Page
Kit Summary	1
Kit Inventory Checklist	2
Curriculum Fit	4
Background for Instructors.....	6
Instructor's Advance Preparation	13
Lesson 1: Set Up PCR Reactions	15
Lesson 2: Electrophoresis of PCR Products	17
Lesson 3: Drying Gels and Analysis of Results	21
Tips and Frequently Asked Questions	23
Quick Guide	27
Student Manual	30
Lesson 1: PCR Amplification.....	35
Lesson 2: Electrophoresis of PCR Products	40
Lesson 3: Drying Gels and Analysis of Results	46
Appendix A: DNA and PCR in Detail.....	49
Appendix B: A Brief History of Forensic Testing <i>Testing Speed vs. Power Discrimination</i>	57
Appendix C: Exercises in STR Allele Frequencies and Random Match Probabilites	66
Appendix D: PCR Amplification and Sterile Technique	71
Appendix E: Glossary of Terms	72
Appendix F: Programming Instructions for MyCycler™ Thermal Cycler	74
Appendix G: Teacher Answer Guide	76
Appendix H: References, Recommended Web Sites, and Career Information	81
Appendix I: Run Agarose DNA Gels in Under 20 Minutes	82

Kit Summary

This kit allows students to conduct real-world forensic DNA analyses and introduces them to the techniques and applications of PCR and gel electrophoresis. As crime scene investigators, students will use PCR and agarose gel electrophoresis to analyze the genotypes of several DNA samples – one obtained from a hypothetical crime scene and four from hypothetical suspects.

- Lesson 1: Set up polymerase chain reactions (PCR)
- Lesson 2: Electrophoresis of PCR products
- Lesson 3: Gel drying and analysis of results

Reagents for gel electrophoresis are available as separate modules; see the kit inventory (page 2) for more information.

The Crime Scene Investigator PCR Basics™ kit provides all necessary reagents (primers, template DNA, and *Taq* polymerase) for students to perform the PCR. After performing PCR, students use electrophoresis to analyze the DNA samples and identify the genotypes using a reference allele ladder. They then match one suspect's DNA sample to the DNA collected at the scene of the crime. Following DNA profiling of a single genetic "locus", the teacher has the option of an additional teaching experience that simulates the use of the 13 core loci used in actual forensic casework. This simple exercise demonstrates the concept of increasing power of discrimination with increasing numbers of loci typed, and illustrates how even siblings can be discretely identified by DNA profiling. Each student team will generate their own set of genotypes, collect and record data on a worksheet, and perform simple statistical calculations.

Note: The reagents provided in this kit only simulate forensic testing. They cannot be used to perform actual genotyping, and as such do not reveal any information about individual genotypes.

Small DNA fragments from 200 to 1000 base pairs are generated in this experiment. To resolve these bands adequately requires a high percentage (3%) agarose gel.

Storage Instructions

Place the reagent bag at -20°C within 1 week of arrival. The other reagents can be stored at room temperature.

Intended Audience

This kit is appropriate for students who have little or no experience with molecular biology or PCR, but may also be suitable for more advanced students with an interest in the details of DNA profiling, forensic science, and statistics. Students should have an understanding of the following concepts to fully appreciate the kit:

- The structure of DNA
- Genotypes and genotyping
- Heredity and the passage of genetic information from parents to offspring
- DNA replication and PCR
- Cell structure and the storage of DNA within the nucleus
- Pattern matching and discrimination

Much of this background information is provided in the instruction manual and the appendices. Additional information can be found in textbooks or web sites referenced in Appendix H.

Kit Inventory Checklist

This section lists the components provided in the Crime Scene Investigator PCR Basics kit. It also lists required accessories. Each kit contains sufficient materials for eight student workstations with a maximum of 4 students per station. As soon as your kit arrives open it and check off kit contents to familiarize yourself with the kit. Immediately place master mix and primers in the freezer (preferably -20°C). The number of gel boxes and pipets you need depends on the number of students you have working at each station. We recommend that 2–4 students work per station.

Kit Components	Number/Kit	(✓)
Crime Scene DNA, 250 μl	1 tube	<input type="checkbox"/>
Suspect A DNA, 250 μl	1 tube	<input type="checkbox"/>
Suspect B DNA, 250 μl	1 tube	<input type="checkbox"/>
Suspect C DNA, 250 μl	1 tube	<input type="checkbox"/>
Suspect D DNA, 250 μl	1 tube	<input type="checkbox"/>
Master mix, 1.2 ml (2x)	1 tube	<input type="checkbox"/>
Crime Scene Investigator primers (blue), 25 μl (50x)	1 tube	<input type="checkbox"/>
Crime Scene Investigator Allele Ladder, 200 μl	1 tube	<input type="checkbox"/>
Orange G loading dye, 1 ml (5x)	1 tube	<input type="checkbox"/>
PCR tubes, 0.2 ml	1 pack	<input type="checkbox"/>
Capless PCR tube adaptors, 1.5 ml	1 pack	<input type="checkbox"/>
2.0 ml colored flip-top microcentrifuge tubes	1 pack	<input type="checkbox"/>
Foam floats	8	<input type="checkbox"/>
Required Accessories	Number/Kit	(✓)
20–200 μl adjustable micropipet	1	<input type="checkbox"/>
2–20 μl adjustable micropipets (#166-0506EDU)	1–8	<input type="checkbox"/>
or, 20 μl fixed volume micropipets (#166-0513EDU)	1–8	<input type="checkbox"/>
2–20 μl pipet tips, aerosol barrier (#211-2006EDU)	8 racks	<input type="checkbox"/>
20–200 μl pipet tips, aerosol barrier (#211-2016EDU)	8 racks	<input type="checkbox"/>
Marking pens	8	<input type="checkbox"/>
Distilled water	3.5 L	<input type="checkbox"/>
Water bath (#166-0504EDU)	1	<input type="checkbox"/>
Microcentrifuge (#166-0602EDU) or mini centrifuge (#166-0603EDU)	1–4	<input type="checkbox"/>
Thermal cycler (e.g. MyCycler™ #170-9701EDU)	1	<input type="checkbox"/>
Power supply (PowerPac™ Basic #164-5050EDU)	2–4	<input type="checkbox"/>
Horizontal gel electrophoresis system, includes mini caster (#166-4288EDU)	1	<input type="checkbox"/>
Small DNA Electrophoresis Reagent Pack (#166-0450EDU) containing 25 g agarose, 100 ml 50x TAE, & 100 ml Fast Blast™ DNA stain	1	<input type="checkbox"/>
Optional Accessories	Number/Kit	(✓)
GelAir™ drying system (#166-1771EDU)	1	<input type="checkbox"/>
Cellophane (if not using GelAir system; #165-1779EDU)	1	<input type="checkbox"/>
Rocker (#166-0709EDU)	1	<input type="checkbox"/>

Refills Available Separately

Reagents Bag (#166-2601EDU): containing master mix, Crime Scene Investigator primers, Crime Scene Investigator Allele Ladder, Orange G loading dye, and Crime Scene and Suspect DNAs.

Master mix, 1.2 ml, contains 60 units of *Taq* DNA polymerase, dNTPs, MgCl₂ and proprietary buffer pH 8.0.

Small DNA Electrophoresis Reagent Pack (#166-0450EDU) containing 25 g agarose, 100 ml 50x TAE, & 100 ml Fast Blast DNA stain.

Medium DNA Electrophoresis Reagent Pack (#166-0455EDU) containing 125 g agarose, 1 L 50x TAE, & 100 ml Fast Blast DNA stain.

Large DNA Electrophoresis Reagent Pack (#166-0460EDU) containing 500 g agarose, 5 L 50x TAE, & 2 x 200 ml Fast Blast DNA stain.

200 µl thin walled PCR tubes, 1,000 (#223-9473EDU).

Curriculum Fit

This curriculum is in keeping with the movement away from traditional science teaching, which includes memorizing scientific facts and information, covering many subject areas, and concluding inquiries with the result of an experiment. Instead, we encourage engaging students in investigations over long periods of time, learning subject matter in the context of inquiry, and applying the results of experiments to scientific arguments and explanations.

The student's focus is not so much on the answer or the result, but on how the result was obtained and substantiated by careful observation and analysis of their data. In this activity, students engage in a scientific process by which they amplify DNA samples using PCR, use gel electrophoresis to identify matched DNA samples, and use simple calculations to understand whether a DNA match could be due to chance. It is suggested that students learn the subject matter before performing the experiment. Students will learn about PCR, gel electrophoresis, genotyping, and genotype matching while asking the question "How can a tiny amount of genetic material (DNA) be used to identify one person out of a billion?" In the context of a crime scene case study scenario, this activity could raise a host of questions such as "Why is this important to the criminal justice system?", or, "If there were a way to free someone from jail who was wrongly convicted, isn't it important to do so?"

This kit is designed to create context and reinforce learning by integrating multiple core content subjects into a single unit or lab. It is the intention of this curriculum to provide concepts and techniques and to put them into context with real-world scenarios.

More specifically, the kit covers the following content standards:

Scientific Inquiry

- DNA profiling via PCR and gel electrophoresis
- Use of controls
- Interpretation of experimental results
- Use of scientific evidence in the courts

Chemistry of Life

- Chemical properties of cell components
- Gel electrophoresis of DNA
- DNA replication and PCR

Heredity & Molecular Biology

- Mendelian genetics
- Genetics of noncoding DNA
- Polymorphic loci and multiple alleles
- Short tandem repeats
- DNA profiling techniques
- Genetics of noncoding DNA

Structure & Function of Organisms

- Structure of the human genome
- Cell structure

Evolutionary Biology

- Genetic diversity and individual identification
- Allele frequencies in populations
- Statistics and probabilities

Environmental & Health Sciences

- Population genetics
- Role, place, limits, possibilities of science and technology
- Genetic screening and databases

More specifically, in the US the kit covers the following content standards:

Standard

Fit to Standard

Content Standard A

Students will develop abilities to do scientific inquiries

Students will perform an experiment using sophisticated procedures

Students will develop understanding about scientific inquiry

Students will apply the results of their experiment to scientific arguments

Content Standard C

Students will develop an understanding of the molecular basis of heredity

Students will understand that genetic information is passed from parents to children

Content Standard E

Students will develop an understanding about science and technology

Students will perform an experiment using sophisticated procedures, and will gain an understanding of technology as it is used in forensic studies

Content Standard F

Students will develop an understanding of science and technology in local, national, and global challenges

Students will learn about how technology is used in identification of victims in disasters, how it is used in the courts, and how technology can be used to reveal familial relationships

Content Standard G

Students will develop an understanding of science as a human endeavor

Students will work together in teams to achieve a common goal

Students will develop an understanding of the nature of scientific knowledge

Students will perform their own experiments and come to their own conclusions based on their experimental observations

Background for Teachers

DNA: Blueprint for Life

DNA is the molecule that guides every aspect of life. It encodes all the information needed to make precisely one of you, a blade of grass, or a worm, and the exact same DNA is found in every cell in your body. DNA is composed of 4 basic repeating units, called nucleotides. In total, each cell in your body contains about 3 billion nucleotides. The complete nucleotide composition of a person is called that person's genome.

Recently, several groups working together finished decoding the entire nucleotide sequence of the human genome. This amazing feat took over 10 years, and required thousands of personnel working full time on the project. Remarkably, when you compare the genomes of any two people, most of the sequence is identical. In fact, greater than 99.5% of the nucleotide sequence would be the same. The remaining 0.5% (or approximately 15 million nucleotides) determines the difference between people.

Nucleotides are strung together in long, tightly packed, double-stranded chains called chromosomes. Chromosomes differ in size, ranging from about 50 million up to about 500 million nucleotides in length. Each human cell contains 23 pairs of chromosomes. Each chromosome is made up of regions, called genes, which direct the expression of a single molecule. With the completion of the Human Genome Project, we now know that there are only about 30,000 genes in humans. Just 30,000 genes to make one human being! One surprising outcome of the Human Genome Project was just how few genes are encoded in the human genome, and how much of the genome is made up of noncoding sequences. What these non-coding sequences do is not clear. Recently, it has been proposed that these sequences may perform regulatory, and other, functions.

The most important part of any cell's life is when it commits to reproducing itself and dividing. The basic result of any cell division is the creation of two identical daughter cells from one original cell. To ensure that this happens, DNA replication must have a high degree of specificity and accuracy. To do so, the enzymes involved in DNA replication use the information already contained in the existing strands to make new DNA copies. This basic idea - the exact copying of DNA from a template - is the basis for a new technology, the polymerase chain reaction (**PCR**), which has revolutionized many areas of science, medicine, and the courts.

Introduction to PCR

In 1983, Kary Mullis, then working at Cetus Corporation, developed the molecular biology technique that revolutionized genetic research, and earned him the Nobel Prize in 1993. PCR transformed molecular biology into a multidisciplinary research tool. Many molecular biology techniques used before PCR were labor intensive, time consuming and required a high level of technical expertise. In addition, working with tiny amounts of DNA made it difficult for researchers in other biological fields (pathology, botany, zoology, pharmacy, etc.) to use molecular biology in their research.

PCR has since had a tremendous impact on five main areas of biotechnology: gene mapping, cloning, DNA sequencing, gene detection and DNA profiling. In fact, PCR is now used routinely as a medical diagnostic tool to detect specific mutations that may cause genetic disease, in criminal investigations, and in courts of law to identify suspects on a molecular level.

Before PCR, the use of molecular biology techniques for therapeutic, forensic, pharmaceutical, or medical diagnostic purposes was impractical or cost-prohibitive. The development of PCR changed molecular biology from a difficult science to one of the most accessible and widely used sets of tools in genetic and medical research today.

PCR and Biotechnology — What Is It and Why Did It Revolutionize an Entire Research Community?

PCR produces exponentially large amounts of a specific piece of DNA from trace amounts of starting material (template). The template can be any form of double-stranded DNA. A researcher can take trace amounts of DNA from a drop of blood, a single hair follicle, a cheek cell, or a piece of bone and use PCR to generate millions of copies of a desired DNA fragment. In theory, only a single intact strand of template DNA via PCR is needed to generate millions of new DNA molecules. Prior to PCR, it would have been impossible to do forensic or genetic studies with this small amount of DNA. The ability to amplify the precise sequence of DNA that a researcher wishes to study or manipulate is the true power of PCR.

PCR amplification requires the presence of at least one DNA template strand. In this kit, DNA samples obtained from a simulated crime scene and several suspects will be the source of the template strands. One of the main reasons PCR is such a powerful tool is its simplicity and specificity. All that is required are inexpensive reaction buffers, four DNA subunits (deoxynucleotide triphosphates of adenine, guanine, thymine, and cytosine), a DNA polymerase, two DNA primers, and minute quantities of the template strand that contains the target sequence you wish to amplify. Specificity comes from the ability to target and amplify one specific segment of DNA out of a complete genome.

That one can make millions of exact copies of a particular DNA sequence easily and cheaply – is now the basis for much of forensic DNA testing. It allows forensic analysts to determine the precise genetic identity of an individual from the tiniest amount of biological material.

A Brief History of Forensic analysis

Forensic sciences describe the boundary between science and the law. Science can as easily convict someone of a crime as free someone wrongly convicted. The earliest uses of science for criminal investigations involved the use of photographs to document crime scenes. Fingerprint evidence has been in use for the past 100 or so years. The first genetic evidence to be collected for investigative work involved the use of blood group typing. The 1980's saw the first use of a DNA-based forensic test, restriction fragment length polymorphism analysis, or RFLP. Although RFLP analysis has its significant limitations (RFLP analysis is described in more detail in Appendix B), it has been the mainstay of forensic analysis for nearly 20 years. Only with the recent advent of PCR has this aspect of the criminal justice system become truly modernized. Modern forensic DNA profiling makes it possible to distinguish any two people on the planet (with the exception of identical twins), living or dead.

Forensic DNA Testing: the Invisible Truth

Imagine the following scenario...

Scene: The Highway Motel, #1 Dark Highway, Nowhere

Setting: Room #13.

The motel manager hears loud male voices, a woman screams, and a shot rings out. The manager runs to the window in time to see the receding lights of a car leaving in a hurry. The door to room # 13 hangs open. The manager runs to the open door, to see a man lying face down in a pool of blood. He calls 911. The police arrive, and begin to examine the crime scene. An apparent homicide, but with no obvious clues as to who committed the crime. Or...?

A forensic specialist is called in to examine the crime scene and collect evidence. Even though it looks like the people involved left no evidence behind, the specialist can use laboratory tests that can tell who was at the crime scene from a single drop of blood or a lone hair. Is this a science fiction story, or reality?

Very much a reality. Testing is routinely done in forensic testing labs across the US and in many other parts of the world from only a single cell, and sometimes from samples that are decades old. The reason this is possible is because of DNA.

To be able to perform laboratory tests, the specialist needs biological material from which intact DNA can be extracted. Often, there is very little material left at the scene of a crime, and not in quantities that will allow analysis. To get around this problem, the specialist takes advantage of a process that each and every cell in your body uses to make new copies of DNA needed each time a cell divides. DNA replication must happen at every cell division, it must happen in only a few short hours, and it must copy all 3 billion nucleotides perfectly. The enzyme that is responsible for this incredible feat is the same enzyme that is used in PCR to amplify DNA sequences of interest for study.

Allele frequencies and the Power of Discrimination

Imagine a scenario in which suspect A and suspect B are accused of being involved in a love triangle and committing the murder of a third person in the Highway Motel; the person who actually pulled the trigger is unknown. In addition to DNA samples from the crime scene, the forensic specialist will isolate DNA from suspects, victims, and any others present to genotype as controls. Using PCR-based analysis, the samples will be examined at 13 different loci using genotyping software to interpret the results from the amplification products. In real crime scene analyses, DNA profiling is performed at many loci to improve the **power of discrimination** of the testing. In simple terms, the power of discrimination is the ability of the typing to discriminate between different individuals. The larger the number of loci typed, the more powerful the ability to discriminate.

To illustrate the power of discrimination, let's take another look at the case involving suspect A and suspect B. At the locus used for this analysis, TH01, there are twelve possible alleles. For example, suspect A has one allele with 6 repeats, and one allele with 3 repeats, giving a DNA profile for the TH01 locus of 6-3 (see Figure 2). In the figure, each repeat of TCAT is represented by a box.

Two sample TH01 genotypes

Suspect A's DNA type for the TH01 locus is (5-3) Suspect B's DNA type for TH01 locus is (6-10)
C C C □ □ □ □ □ **A A A** **5*** **C C C** □ □ □ □ □ □ □ □ □ □ **A A A** **6***
C C C □ □ □ □ **A A A** **3*** **C C C** □ □ □ □ □ □ □ □ □ □ □ □ □ □ □ □ **A A A** **10***

* Number of [TCAT] repeats

Fig. 2. Sample TH01 genotypes

A schematic diagram of the results for TH01 typing for suspect A and suspect B is illustrated in Figure 3. In this example, PCR has been performed on DNA from the 2 suspects using primers specific for the TH01 locus. Following gel electrophoresis, the pattern of resulting bands are compared to the Allele Ladder to identify the alleles present in the samples.

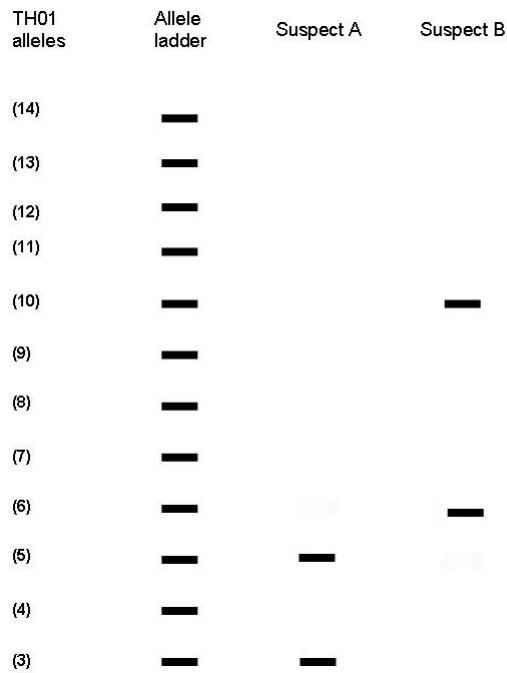

Fig. 3. Illustration of sample TH01 genotypes following gel electrophoresis.

Now it just so happens that allele frequencies don't follow regular mathematical patterns. In fact, allele frequencies change according to the population under study. To illustrate this point, take a look at the following graph (Figure 4).

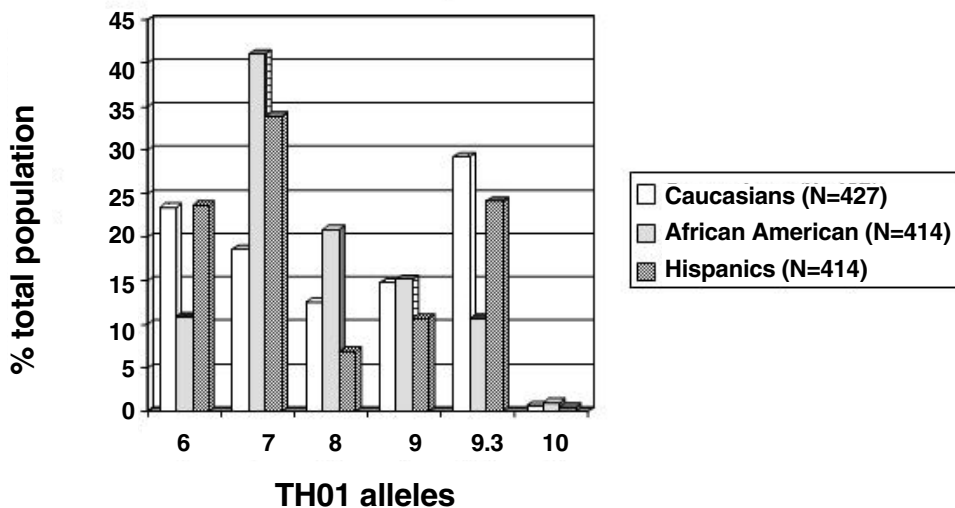

Fig. 4. TH01 allele frequencies among different ethnic groups.

According to the data at the TH01 locus, Caucasians are more likely to have either allele 6 or allele 9.3, but hardly ever have allele 10. Similarly, most African Americans have allele 7 at this locus, but almost never have allele 10.

Because of how chromosomes are inherited (described by Mendel's Law of Independent Assortment), the frequency of each allele can be multiplied together to give you a genotype frequency. First, let's look at the D3S1358 locus, another locus used in DNA profiling in addition to TH01. Let's say that at the D3S1358 locus suspect A has a copy of allele 16 (allele frequency = 0.253 for Caucasians) and a copy of allele 17 (allele frequency = 0.215 in Caucasians). At this locus, this particular combination of alleles is seen fairly frequently in Caucasians, and the allele frequency of this combination of alleles works out to $2 \times (0.253) \times (0.215) = 0.109$, or about 1 out of every 10 Caucasians. If you were investigating this crime, and these particular genotypes were found at the crime scene, that's not very good news for your case! That means that many Caucasians could have been involved in the crime. The essential job of investigating a crime is ruling out, or excluding, suspects. How does DNA profiling make that happen?

It does so by examining many different loci at the same time. Now, in addition to D3S1358, let's examine the TH01 locus. At the TH01 locus, suspect A has two copies of TH01 allele 10. For Caucasians, the allele frequency of a single copy of allele 10 is 0.008. For a Caucasian person with two copies of allele 10, the total allele frequency at the TH01 locus is then $(0.008) \times (0.008) = 0.000064$, which works out to 1 out of every approximately 15,600 Caucasians. If you combine the TH01 allele frequency for this person with that of the D3S1358 allele frequency, that works out to a combined allele frequency of $(0.109) \times (0.000064) = 0.000007$, or 1 out of every 150,000 or so Caucasians. So, the more loci you add to your analysis, the better the power of discrimination becomes. Or, put another way, the smaller your suspect pool becomes.

To think of this another way, examine figure 5, where you have a pool of 13 potential suspects (stars) implicated in a crime. Using STR analysis, you discover that 6 of the potential suspects have the TH01 genotype of 6-3, which is a genotype found at the scene of the crime. The other 7 samples have a different genotype at the TH01 locus. So, in the

analysis of this one allele, you were able to exclude 7 suspects. However, you still have 6 possible suspects. Were they all present at the scene of the crime? To answer this question, you also analyze the D3S1358 locus. Here, you find that 7 suspects have the D3S1358 genotype 16-17, a genotype which is also present at the crime scene. Of those 7 suspects, 4 of them also have a TH01 genotype of 6-3. By combining these two genotypes, you can exclude 2 more suspects, and increase your power of discrimination. To be able to tell if all 4 of the remaining suspects were present at the crime scene, you also look at the FGA locus, and discover that the 21-23 genotype is found at the crime scene. In your pool of suspects, 7 people have that genotype at that locus. However, when combined with the results from the TH01 allele and the D3S1358 allele, you find that only one of your 13 suspects has the same genotype as was found at the crime scene. Now, after analyzing 3 different loci, you can exclude all but one of your suspects.

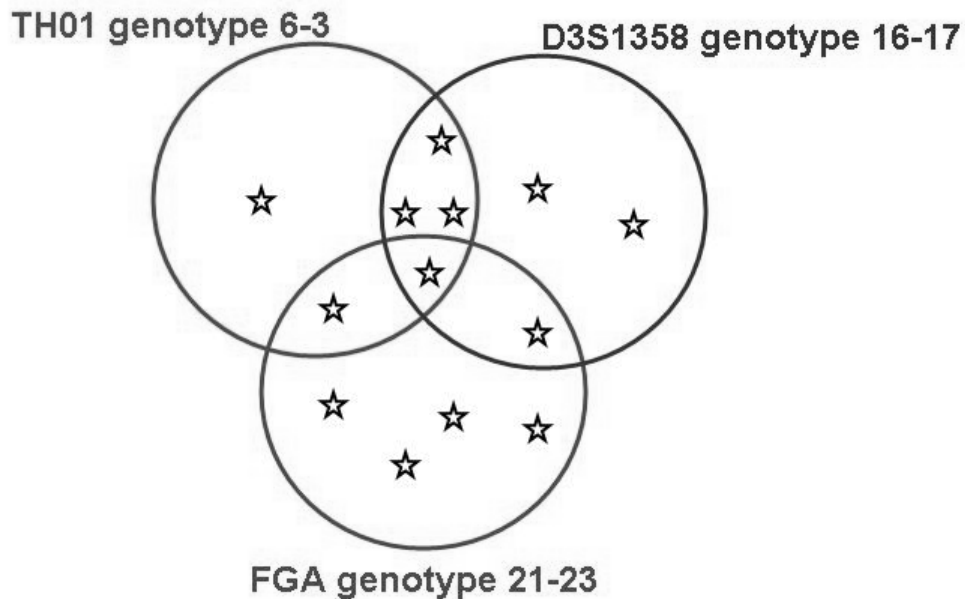

Fig. 5. The Power of Discrimination increases as the number of loci tested increases.

As illustrated in these examples, the power of discrimination changes depending on the loci and the ethnicity of the samples involved in an investigation. This phenomenon presents special challenges for any investigation! This topic is addressed in more detail in Appendices B and C.

STR analysis can help reveal family relationships

In addition to solving crimes, DNA evidence has also been used to solve other issues such as familial relationships. Taking the example above (Figure 3), assume that A and B are the parents of several children. Perhaps the father passes away in a natural disaster. Fortunately, the father's insurance benefits cover all family members in the event of his death. However, the insurance agency is refusing to pay for health costs related to the youngest child (child C), since child C was born after the husband died, and the agency has only the mother's assurance who the father is. Since she knows that STR alleles are inherited from each parent, the mother has an STR test done on herself, her child, and a sample from the father. The results are shown in Figure 6.

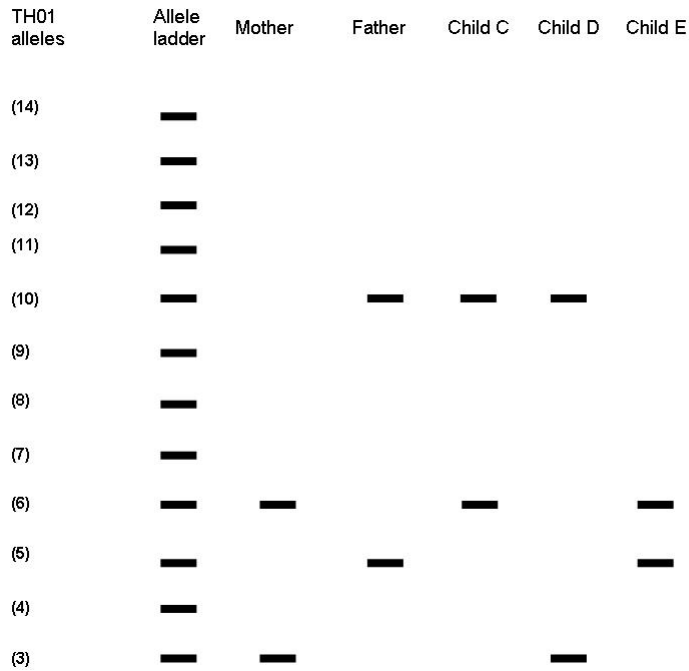

Fig. 6. TH01 alleles used to demonstrate familial relationships.

The result shows that for this particular locus, the pattern of alleles present in the children resembles that of the parents. That is, all the children have alleles represented in the samples from both parents, and so it is likely that these two people are the parents of these children. In reality, many more alleles are actually tested, but the basis is the same – related individuals must share some of the same alleles.

Crime Scene Investigator PCR Basics™ Kit

In this kit, students perform PCR reactions on a mixture of plasmid DNA templates using a pair of PCR primers. The resulting PCR products range in size from 200 to 1,000 bp, and are resolved on high percentage agarose gels. A DNA allele ladder, containing bands in the range of 100 up to 1,500 bp, is run alongside PCR products to allow identification of 'alleles' and to give an estimation of PCR product size. Following agarose gel electrophoresis, students stain the gels, visualize the products, compare them to a DNA ladder of possible alleles, and assign a genotype for the templates. Students will then look to see if any of the suspects' genotype matches the crime scene, and see whether they can identify the perpetrator!

Instructor's Advance Preparation

This section describes the preparation to be performed by the instructor prior to each laboratory period. If block periods are used, then prepare for Lesson 1 first; lessons 2 & 3 may be prepared at the same time if block periods are used. An estimation of preparation time is included. It is highly recommended that aerosol barrier or filter tips be used for aliquoting all reagents.

Timeline

The lab requires a minimum of three 50 minute laboratory lessons or two 90 minute block lessons. Be aware that a 2.5 hour cycling period is needed outside of class time, typically done overnight. We also recommend 2–3 days of background review and lectures to prepare your students for the exercise.

Prior to Lab

- Read manual (2 hr)
- Inventory required accessories (~ 30 minutes)
- Perform instructor's advance preparation (30 min–1 hr per lab)
- Set up student workstations (30 min–1 hr per lab)

50-minute Lab Lessons

- Lesson 1: Set up PCR reactions (50 min)
- Run PCR reactions (~ 3 hr)—typically overnight
- Lesson 2: Electrophoresis of DNA and staining of gels (50 min)
- Lesson 3: Analysis of results (50 min)

Block Lessons

- Lesson 1 – set up PCR reactions
- Run PCR reactions (~ 3 hr) – typically overnight
- Lessons 2 & 3: Electrophoresis of DNA, staining of gels, analysis of results (90 min)

Safety Issues

Eating, drinking, smoking, and applying cosmetics are not permitted in the lab area. Wearing protective eyewear and gloves is strongly recommended. Students should wash their hands with soap before and after this exercise. If any of the solutions get into a student's eyes, flush with water for 15 minutes. Although Fast Blast DNA stain is not toxic, latex or vinyl gloves should be worn while handling the stain to keep hands from becoming stained. Lab coats or other protective clothing should be worn to avoid staining clothes.

Volume Measurements

This kit requires the use of adjustable- or fixed-volume micropipets to measure small volumes (less than 1 ml). Instructors may wish to review the use of micropipets before students use them in an experiment.

Lab Scenario Suggestion

To more effectively engage students in the activity, instructor's may elect to set up a crime scene in the laboratory, with stations set up around the laboratory containing aliquots of DNAs extracted from the crime scene and various suspects. A pre-lab activity could be performed with a number of props setup from the crime scene to engage students in thinking about what kinds of items contain DNA evidence. For suggestions on how to set up a crime scene, and a web-based interactive DNA fingerprinting laboratory game, go to <http://ppge.ucdavis.edu/software/VDNA.htm>.

Lesson 1 Set Up PCR Reactions

Materials Needed for Advanced Preparation	Quantity
PCR tubes	40
PCR tube adapters	40
2.0 ml mixed color flip-top microcentrifuge tubes	49
Master Mix (2x)	1 vial
Crime Scene Investigator primers (blue; 50x)	1 vial
Crime Scene DNA	1 vial
Suspect A DNA	1 vial
Suspect B DNA	1 vial
Suspect C DNA	1 vial
Suspect D DNA	1 vial
100–1,000 μ l adjustable micropipet	1
100–1,000 μ l pipet tips, aerosol barrier	1 rack
2–20 μ l adjustable micropipet or 20 μ l fixed volume micropipet	8
2–20 μ l pipet tips, plugged	8 racks
Beakers with ice or ice baths	8
Foam floats	8
Marking pens	8

Procedure (Estimated Time: 45 min)

Step 1: Thaw master mix, primers, Crime Scene DNA, and Suspect DNA templates at room temperature. Pulse-spin in centrifuge to bring all contents to bottom of tubes. Store tubes on ice while out of the freezer. Time required–10 minutes.

Step 2: Label tubes: time required–10 minutes

- Label 9 yellow 2.0 ml microcentrifuge tubes "MMP"
- Label 8 purple 2.0 ml microcentrifuge tubes "CS" (for Crime Scene)
- Label 8 green 2.0 ml microcentrifuge tubes "A" (for Suspect A)
- Label 8 blue 2.0 ml microcentrifuge tubes "B" (for Suspect B)
- Label 8 orange 2.0 ml microcentrifuge tubes "C" (for Suspect C)
- Label 8 pink 2.0 ml microcentrifuge tubes "D" (for Suspect D)

Step 3: Preparing master mix + primers (MMP).

Note: If you plan to use the kit for more than one class, it is recommended that you thaw only as much master mix as you will use for one class. It is not recommended that MMP (master mix plus primers) be prepared more than one hour before use, regardless of storage temperature.

Perform this step no more than–1 hour before the lab. Using an adjustable-volume micropipet set to 1,000, pipet **1,000 μ l of master mix** to one of the tubes labeled MMP. Using either a 2–20 μ l adjustable micropipet set to 20 μ l, or a fixed volume 20 μ l pipet, add **20 μ l of Crime Scene Investigator Primers** to the same tube. Mix well and pulse-spin to bring the contents to the bottom of the tubes. The solution should be noticeably blue. Store on ice. Time required–10 minutes.

Note: Be sure to pulse-centrifuge the primers before aliquoting to ensure the contents are not caught up in the tube lid.

- Step 4: Using a 20–200 µl adjustable-volume micropipette set to 120 µl, add 120 µl of master mix with the newly added primers (MMP) into the 8 remaining yellow tubes labelled MMP. Place each tube into a foam float and place the foam floats on ice.
- Step 5: Using an adjustable-volume micropipet set to 25 µl, add 25 µl Crime Scene DNA template to the 8 purple tubes labeled "CS".
- Step 6: Add 25 µl Suspect A DNA template to the 8 green tubes labeled "A".
- Step 7: Add 25 µl Suspect B DNA template to the 8 blue tubes labeled "B".
- Step 8: Add 25 µl Suspect C DNA template to the 8 orange tubes labeled "C".
- Step 9: Add 25 µl Suspect D DNA template to the 8 pink tubes labeled "D".
- Step 10: Put one of each of the DNA tubes in each ice bath using the foam float.
- Step 11: Set up student workstations. Time required–15 minutes.

Setup Student Workstations (Lesson 1)

Materials Needed for Advanced Preparation	Quantity
Ice bath containing DNA samples and MMP	total 6 tubes
MMP (blue liquid)	1
Crime Scene DNA (purple tube)	1
Suspect A DNA (green tube)	1
Suspect B DNA (blue tube)	1
Suspect C DNA (orange tube)	1
Suspect D DNA (pink tube)	1
PCR tubes	5
PCR adaptors	5
Foam float	1
Permanent marking pen	1
2–20 µl adjustable micropipet or fixed volume 20 µl micropipet	1
2–20 µl pipet tips, aerosol barrier	1 rack

- Step 12: Program thermal cycler (see appendix F for detailed instructions on programming the Bio-Rad MyCycler™ thermal cycler)

Step	Function	Temp	Duration	Number of cycles
Initial Denature	Denature	94°C	2 min	X1
Thermal cycling	Denature	94°C	30 sec	X35
	Anneal	52°C	30 sec	
	Extend	72°C	1 min	
Final Extend	Extend	72°C	10 min	X1
Hold	Hold	4°C	Forever	X1

Lesson 2 Electrophoresis of PCR Products

Small DNA fragments of 200 to 1000 base pairs are generated in this experiment, and require a high percentage agarose gel to resolve them adequately. We recommend 3% agarose gels for optimal fragment separation and resolution.

Materials Needed for Advanced Preparation	Quantity
Orange G Loading Dye (5x)	1 vial
Crime Scene Investigator Allele Ladder	1 vial
1.5 ml microcentrifuge tubes	16 tubes
20–200 µl adjustable micropipet	1
20–200 µl pipet tips	1 rack
2–20 µl adjustable micropipets or fixed volume 20 µl micropipets	8
2–20 µl pipet tips, aerosol barrier	8 racks
Power supply	2–4
Fast Blast DNA Stain	1 bottle
Flask or bottle to store diluted Fast Blast DNA stain	1
Distilled water	3.5 L
Gel staining trays	1–8
Electrophoresis materials and equipment	See below

Procedure (Estimated time: 1–3 hr)

Time required for steps 1 to 5–20 minutes

- Step 1: Thaw Orange G loading dye and the Allele Ladder and pulse spin in centrifuge to bring contents to bottom of tubes.
- Step 2: Add 50 µl of Orange G loading dye to the Allele Ladder. This creates the Orange G Allele Ladder. Mix well and pulse spin in centrifuge to bring contents to bottom of the tube.
- Step 3: Label microcentrifuge tubes –
- Label 8 tubes "LD", for loading dye
 - Label 8 tubes "Allele ladder"
- Step 4: Add 60 µl of Orange G loading dye into the 8 tubes marked "LD". Store at 4°C for up to 2 weeks.
- Step 5: Add 25 µl of Orange G Allele Ladder with added Orange G loading dye (from step 2 above) into the 8 tubes marked "Allele ladder". Store at 4°C for up to 2 weeks.
- Note:** because the Allele ladder + Orange G is difficult to distinguish from Orange G loading dye itself, instructors may wish to hold the Allele ladder at the instructor's workstation and have students collect an aliquot when they are ready to run gels.
- Step 6: Prepare gels, running buffer and electrophoresis apparatus. Refer to the instructions below for preparing agarose gels. Time required–30 minutes to one hour.
- Step 7: Prepare Fast Blast DNA stain. Refer to the instructions below for staining. Time required–15 minutes.
- Step 8: Set up student workstations. Time required–15 minutes.

Set up Student Workstations

Materials needed	Quantity
3% agarose gel (see below)	1
PCR Samples from previous lab	5
Running buffer (see below)	300–350 ml
Orange G loading dye	1 tube
Orange G Allele Ladder	1 tube
2–20 μ l adjustable volume pipet or fixed volume 20 μ l micropipet	1
2–20 μ l pipet tips, aerosol barrier	1 rack
Gel electrophoresis chamber (may be shared by 2 workstations)	1
Power supply (may be shared by multiple workstations)	1
Fast Blast DNA stain (at common workstation)	1
Gel staining tray	1

Prepare of Agarose Gels and TAE Running Buffer

These procedures may be carried out 1 to 2 days ahead of time by the instructor or done during class by individual student teams.

Note: Convenient precast 3% agarose gels (#161-3017EDU) are also available from Bio-Rad. Time required–30 minutes to one hour.

Materials Needed	Quantity
Agarose	10.5 g
50x TAE	60 ml
Graduated cylinders, 3 L and 500 ml	2
Microwave or magnetic hot plate and stir bar	1
Bottle or Erlenmeyer flask, 1 L	1
Flask, 50 ml (optional)	1
Waterbath at 60°C (optional)	1
Gel casting trays	4–8
Gel combs	8
Lab tape (optional)	1 roll
Horizontal electrophoresis chamber	4–8

Step 1: Prepare electrophoresis buffer. The electrophoresis buffer is provided as a 50x concentrated solution. 1x TAE buffer is needed to make the agarose gel and is also required for each electrophoresis chamber. Three liters of 1x TAE buffer will be sufficient to run 8 electrophoresis chambers and pour 8 agarose gels. To make 3 L of 1x TAE from a 50x TAE concentrate, add 60 ml of concentrate to 2.94 L of distilled water. Time request–10 minutes.

Step 2: Make the agarose solution. The recommended gel concentration for this classroom application is 3% agarose. This agarose concentration provides excellent resolution and minimizes run time required for electrophoretic separation of PCR fragments. To make a 3% solution, add 3 g of agarose to 100 ml of 1x TAE electrophoresis buffer. For 8 gels, you will need approximately 350 ml of molten agarose (10.5 g agarose per 350 ml 1x TAE buffer). The agarose must be made using electrophoresis buffer, **not** water. Add the agarose powder to a suitable container (e.g., 1,000 ml Erlenmeyer flask, Wheaton bottle, etc.). Add the appropriate amount of 1x TAE electrophoresis buffer and swirl to suspend the agarose powder in the buffer. If using an Erlenmeyer flask, invert a 50 ml Erlenmeyer flask into the open end of the 1,000 ml Erlenmeyer flask containing the agarose. The small flask acts as a reflux chamber, allowing boiling without much loss of buffer volume. The agarose can be melted for gel casting on a magnetic hot plate or in a microwave oven. **Caution:** Use protective gloves, oven mitts, goggles, and lab coat as appropriate while preparing and casting agarose gels. Boiling molten agarose or the vessels containing hot agarose can cause severe burns. Time required—10 minutes.

Magnetic hot plate method. Add a stir bar to the flask containing agarose and buffer. Heat the mixture to boiling while stirring on a magnetic hot plate. Bubbles or foam should disrupt before rising to the neck of the flask. Boil the solution until **all** of the small transparent agarose particles are dissolved. With the small flask still in place, set aside the agarose to cool to 60°C before pouring gels (a waterbath set to 60°C is useful for this step).

Microwave oven method. Place the agarose solution into the microwave. Loosen the bottle cap if present. Use a medium setting and set to 3 minutes. Stop the microwave oven every 30 seconds and swirl the flask to suspend any undissolved agarose. This technique is the fastest and safest way to dissolve agarose. Boil and swirl the solution until all of the small transparent agarose particles are dissolved. With the small flask still in place, set aside to cool to 60°C before pouring (a waterbath set to 60°C is useful for this step).

Cast Agarose Gels (time required—10 minutes)

Using Bio-Rad's Mini-Sub[®] Cell GT system, gels can be cast directly in the gel box by using the casting gates with the gel tray. If casting gates are unavailable, use the taping method for casting gels, as outlined below. Other methods are detailed in the Bio-Rad Sub-Cell[®] GT instruction manual. 7 x 7 cm gel trays allow a single gel to be cast. 7 x 10 cm gel trays allow a double stacked gel to be cast, i.e. a gel with two sets of wells that can be loaded with the samples of two student teams. These longer gels do not fit the casting gates and need to be taped.

- Step 1: Seal the ends of the gel tray securely with strips of standard laboratory tape. Press the tape firmly to the edges of the gel tray to form a fluid-tight seal.
- Step 2: Level the gel tray on a leveling table or workbench using the leveling bubble provided with the instrument.
- Step 3: Prepare the desired concentration and amount of agarose in 1x TAE electrophoresis buffer.
- Step 4: Cool the agarose to at least 60°C before pouring (a waterbath is useful for this step).
- Step 5: While the agarose is cooling to 60°C, place the comb into the appropriate slot of the gel tray. Gel combs should be placed within 3/4" of an inch of the end of the gel casting tray (not in the middle of the gel).
- Step 6: Pour 30–50 ml of molten agarose into the tray to a depth of approximately 0.5 cm.
- Step 7: Allow the gel to solidify at room temperature for 10 to 20 minutes – it will appear cloudy and translucent when ready to use.

- Step 8: Carefully remove the comb from the solidified gel. Remove the tape from the edges of the gel tray.
- Step 9: Place the tray into the leveled DNA electrophoresis chamber so that the sample wells are at the cathode (black) end of the base. DNA samples will migrate towards the anode (red) end of the base during electrophoresis.
- Step 10: Fill the electrophoresis chamber with 1x TAE running buffer to about 2 mm above the surface of the gel.
- Step 11: Load gel in manner directed in student manual
- Step 12: Run gel 100 V for 30 minutes. If double stacked gels are used, take care to only run gels at 100 V for 30 min since the DNA from the upper gel may run into the lower gel. Do not let the orange dye front migrate off the gel.
- Step 13: Stain gel in Fast Blast DNA stain (see below).

Prepare Fast Blast DNA Staining Solution (time required–10 minutes)

Fast Blast DNA stain is provided as a 500x concentrate that must be diluted prior to use. The stain can be used as a quick stain when diluted to 100x to allow the visualization of DNA within 15–20 minutes, or can be used as an overnight stain when diluted to 1x. Fast Blast DNA stain is a convenient, safe, and nontoxic alternative to ethidium bromide for the detection of DNA. Fast Blast contains a cationic compound that belongs to the thiazin family of dyes. The positively charged dye molecules are attracted to and bind to the negatively charged phosphate groups on DNA. The proprietary dye formula stains DNA deep blue in agarose gels and provides vivid, consistent results. Detailed instructions on using Fast Blast are included in the student manual.

WARNING

Although Fast Blast DNA stain is nontoxic and noncarcinogenic, latex or vinyl gloves should be worn while handling the stain or stained gels to keep hands from becoming stained blue. Lab coats or other protective clothing should be worn to avoid staining clothing. Dispose of the staining solutions according to protocols at your facility. Use either 10% bleach solution or 70% alcohol solution to remove Fast Blast from most surfaces. Verify that these solutions do not harm the surface prior to use.

Prepare 1x Fast Blast DNA Staining Solution for Overnight Staining Protocol (Recommended)

To prepare 1x stain (for overnight staining), dilute 1 ml of 500x Fast Blast with 499 ml of distilled or deionized water in an appropriately sized flask or bottle and mix. Cover the flask and store at room temperature until ready to use.

This method is preferred because it results in the most robust staining of DNA while producing low background staining. Although staining overnight often produces the most robust staining, good results can be obtained in a few (4 to 6) hours.

Prepare 100x Fast Blast DNA Staining Solution for Quick Staining Protocol

To prepare 100x stain (for quick staining), dilute 100 ml of 500x Fast Blast with 400 ml of distilled or deionized water in an appropriately sized flask or bottle and mix. Cover the flask and store at room temperature until ready to use.

Destaining requires the use of at least one large-volume container, capable of holding at least 500 ml, at each student workstation. 100x Fast Blast can be reused at least seven times. Please note, in contrast to 1% agarose gels, 3% agarose gels require 5 min staining, prior to destaining in warm water. Due to the high percentage of agarose, gels stained by this quick method may take longer to destain to a satisfactory level than 1% agarose gels. Multiple washes with **warm** tap water will assist the destaining of these gels.

Lesson 3 Drying Gels and Analysis of Results

For a permanent record of the experiment, gels can be dried between cellophane sheets and then adhered to lab books (see method below and Student Manual for protocols). To analyze the wet gels, gels can be scanned, photocopied (a yellow backing provides optimal contrast), or traced onto acetate film.

Note: 3% agarose gels do not adhere well to agarose gel support film.

GelAir™ drying frame method:

Materials Needed for Drying Gels Using GelAir Gel Drying

System (#166-1771EDU)	Quantity
Cellophane sheets (#165-1779EDU)	4
GelAir assembly table (#165-1776EDU)	1
GelAir drying frame (#165-1775EDU)	2
GelAir clamps (#165-1780EDU)	16
GelAir Drying Oven (optional; #165-1777EDU)	1
Distilled water	500 ml

Procedure

- Step 1: Prewet 2 sheets of cellophane in a container of water for 15–20 seconds.
- Step 2: Place a plastic drying frame on the GelAir assembly table. Center one sheet of cellophane on the assembly table.
- Step 3: Carefully lay your gel on the cellophane, positioning it to accommodate other gels (up to 6 total). If there are bubbles between the gel and the cellophane, gently push them out with your gloved finger.
- Step 4: Flood the gels with water and lay the second sheet of cellophane on top of them. If there are any bubbles, gently push them out with a gloved finger. You cannot avoid bubbles at the edges of agarose gels since they are so thick, but avoid bubbles between the cellophane and the face of the gel.
- Step 5: Place the square metal frame on top of the cellophane sandwich. Secure the clamps onto the frame, two on each side. If you are not using a GelAir dryer oven, place the frames in a well-ventilated area for 12–36 hours. If you have a GelAir dryer, place up to four drying frames into the oven, turn the heater switch on and set the dial to 3 hours. The dryer will shut off automatically.
- Step 6: When the gels are completely dry, they will be flat. Remove the clamps and take the gel/cellophane sandwich from the frame. Trim the excess cellophane surrounding your dried gel with scissors. Working carefully so as not to tear the dried gel, gently peel off the excess cellophane. The cellophane adsorbs Fast Blast, and may obscure results.

Alternatively, you may choose to use the cellophane sandwich and plastic container method:

Student Workstation

Materials Needed for each Workstation	Quantity
Cellophane sheets	2
Plastic container—Tupperware type (minimum 6 x 6" opening)	1
Rubber bands	2
Distilled water	500 ml

Procedure

- Step 1: Wet two pieces of cellophane in a large volume of water, approximately 500 ml.
- Step 2: Place one sheet of cellophane over a plastic container. Pull the cellophane taut so that it makes a flat surface over the top of the container, and use a rubber band to secure the sheet in place.
- Step 3: Place a gel onto the cellophane. Remove any air bubbles that are under or around the gel. You cannot avoid bubbles at the edges of agarose gels since they are so thick, but avoid bubbles between the cellophane and the face of the gel. Flooding the surface of the cellophane around the gel with water will aid in the removal of bubbles.
- Step 4: Place the second sheet of wetted cellophane over the gel, being careful not to trap any bubbles. Secure the second sheet of cellophane to the box with a second rubber band.
- Step 5: Allow gel to dry for several days in a well-ventilated area.
- Step 6: When dry, disassemble the apparatus, and remove the dried gel. It is possible to peel the dried cellophane off of the gel. However, take care not to tear the gel.

Tips and Frequently Asked Questions

Lesson 1: Set Up PCR Reactions

Contamination

Students should be reminded to guard against contamination, to use fresh tips at each step of this lab, and to keep tubes capped unless immediately adding a reagent to them. See Appendix D for more information about preparing a working environment free of DNA contamination.

Master Mix: What is it?

The master mix contains a mixture of nucleotide triphosphates, or dNTPs (dATP, dTTP, dCTP, and dGTP), buffer, and *Taq* DNA polymerase. Complete master mix is prepared by adding primers to the master mix just prior to the laboratory period. Thus, when a 20 μ l aliquot of the DNA template is added to a 20 μ l aliquot of complete master mix, all of the necessary components for a 40 μ l PCR reaction are present.

The 2X master mix contains 0.05 units/ μ l *Taq* polymerase, 3 mM MgCl₂, 1.6 mM dNTPs, and 1 μ M of each primer. The final 1x or working concentration of these components in the PCR tube after the primers, master mix, and template are combined will be 0.025 units/ μ l *Taq* polymerase, 1.5 mM MgCl₂, 0.8 mM dNTPs, and 0.5 μ M of each primer.

Note: Once the master mix and primers are mixed, they should be kept on ice and used within 30 minutes–1 hour. Although the optimal temperature for *Taq* is 72°C, it is active over a large temperature range. Keeping *Taq* cold prevents the enzyme from prematurely extending from the primers, and forming artifactual 'primer-dimer' bands.

How Stable Are Newly Set Up PCR Reactions?

Extended incubation of master mix and DNA prior to PCR decreases amplification efficiency. Thus if you wish to put two classes into one PCR machine or if you have more PCR reactions than you have space in your thermal cycler we suggest incubating the reactions on ice for no more than one hour prior to cycling.

Alternatively, only thaw and use as much master mix as you require for each class.

Primers: What are they and why are they needed?

Primers, or oligonucleotides, are short stretches of DNA, usually 3 to 30 nucleotides long, that are complementary to the template that a researcher wants to copy using PCR. Primers are needed because DNA polymerase cannot create a new DNA chain on its own. Instead, it requires a preexisting chain of nucleotides (the primers) to add nucleotides onto. In other words, these short stretches of DNA 'prime' the DNA synthesis reaction. During PCR and DNA replication, DNA polymerase recognizes a complex of single-stranded template DNA plus a primer. More information about this process is described in Appendix A.

Why are the primers blue?

The primer mix contains a PCR-compatible dye (xylene cyanol) that allows students to easily visualize when they have added the master mix + primers to template in the PCR reaction. The dye also migrates in the gel giving a visual demonstration of gel electrophoresis.

PCR in a thermal cycler

The PCR amplification takes place in a thermal cycler that performs cycles of alternating heating and cooling steps. This lab utilizes a three-step cycle: the DNA undergoes

denaturation at 94°C for 30 seconds, annealing at 52°C for 30 seconds, and extension at 72°C for 1 minute (Figure 7). This cycle is repeated 35 times during the course of PCR amplification. During denaturation, the two strands of the DNA template are melted apart to provide access for the PCR primers and for *Taq* DNA polymerase. During the annealing step, the PCR primers recognize and bind to the complementary regions on the DNA template. Once the primers are bound, *Taq* DNA polymerase extends the primers in the 5' to 3' direction to replicate the segment of DNA during the extension step. The PCR reaction will take approximately 2.5 hours to complete.

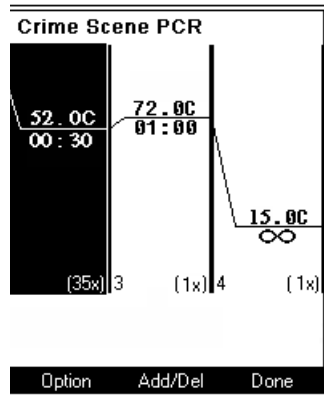

Fig. 7. The Crime Scene Investigator PCR Basics Kit thermal cycling conditions.

PCR tubes are very small and require care when handling. It is important to carefully and completely cap the tubes before placing them into the thermal cycler. If the tubes are not closed completely, substantial evaporation can take place, which can concentrate the salts in the reaction and inhibit PCR.

Bio-Rad's thermal cyclers were developed for oil-free operation. Oil is not needed in the thermal block wells or in the sample tubes. The sample wells are shaped to provide uniform contact with most standard 200 µl thin-wall PCR tubes. **Do not use 500 µl thin-wall micro test tubes with Bio-Rad's thermal cyclers.** The heated sample block cover maintains a higher temperature than the sample block at all times during a thermal cycling program. This keeps water vapor from condensing under the cap of the sample tube, thereby reducing sample evaporation and eliminating the need for oil overlays in the tubes.

Manual PCR

It is possible to perform PCR manually without an automated thermal cycler. For manual PCR amplification, reactions should be performed in screwcap tubes and topped off with a drop of mineral oil to prevent evaporation. The tubes are placed in a heat block or water bath set at 94°C for 30 seconds, then manually transferred to a heat block or waterbath set at 52°C for 30 seconds, and finally transferred to a heat block or water bath set at 72°C for 1 minute. Thirty five cycles of manual PCR should take ~150 minutes. It is tedious but it can work. Good luck!

Lesson 2: Electrophoresis of PCR Products

Orange G Loading Dye

Before the amplified samples are electrophoresed, students need to add 10 µl of 5x Orange G loading dye to each of their PCR tubes. The instructor should also have added Orange G loading dye to the allele ladder before use. The Orange G DNA loading dye contains glycerol, which increases the density of the sample and ensures that it sinks into

the well of the agarose gel. The DNA loading dye contains a dye called Orange G that comigrates at the same rate as a 50 bp DNA fragment toward the anode. Orange G dye is preferred for this experiment because it migrates in an area of the gel where it won't cover or mask any DNA bands.

Dye Migration

The orange dye should not be allowed to migrate off the gel, or some samples may be lost. As a side point, the dye used to color the primers (xylene cyanol) will migrate at a different rate than Orange G due to their relative charge differences and can be used as a real-time visual demonstration of electrophoresis.

Can I use ethidium bromide to stain my gels?

This lab has been optimized for use with Fast Blast DNA stain, a safe, nontoxic DNA stain. Ethidium bromide is the traditional stain used to visualize DNA and has a higher sensitivity than Fast Blast, and will work fine if used to stain gels for this lab. However, ethidium bromide is a known mutagen and suspected carcinogen and requires the use of UV light to visualize DNA. One down side of using ethidium is that, due to its higher sensitivity, primer dimer bands may be more visible than with Fast Blast and may confuse interpretation of results with less experienced students. If ethidium bromide is used as a stain, the gels should contain 0.05 µg/ml ethidium bromide in the agarose. This concentration of ethidium bromide produces maximum contrast of the amplified bands.

Note: Fast Blast DNA stain quenches ethidium bromide staining, so visualize with ethidium bromide before Fast Blast stain.

Lesson 3: Analysis of Results

Allele Ladder

A simulated Allele Ladder is included in the kit that represents all of the possible alleles at the locus being analyzed. The allele ladder contains 8 bands of 1,500, 1,000, 700, 500, 400, 300, 200, and 100 bp in length. From the top to the bottom (see gel in figure 8) these alleles are called 15, 10, 7, 5, 4, 3, 2, and 1. If you chose to stain overnight with Fast Blast, you may find that the smallest bands (100 + 200 bps) become fuzzy. This is a result of diffusion of DNA through the gel. To avoid this artifact, you may wish to stain the gels for a shorter period of time. It is possible to get adequate staining in these high percentage agarose gels after only a few hours in 1x Fast Blast DNA stain. Do not leave your gels staining over the weekend – substantial diffusion can prevent accurate interpretation of results.

How to identify alleles and assign genotypes to a DNA sample

To identify which alleles are represented in a particular DNA sample, compare the migration of the amplified DNA sample to the Allele Ladder and look to see which bands in the PCR reaction matches the corresponding band in the sample. The identity (name) of each allele in the ladder will correspond to the identity of each allele in the suspect being tested. Each DNA sample will generate two bands, representing the two alleles present in the original DNA sample. Go through this process for each band in each DNA sample in order to generate (identify) the genotypes of the suspect samples. Each genotype should be a combination of the two identified alleles.

The picture below shows results similar to what can be seen following performance of the kit.

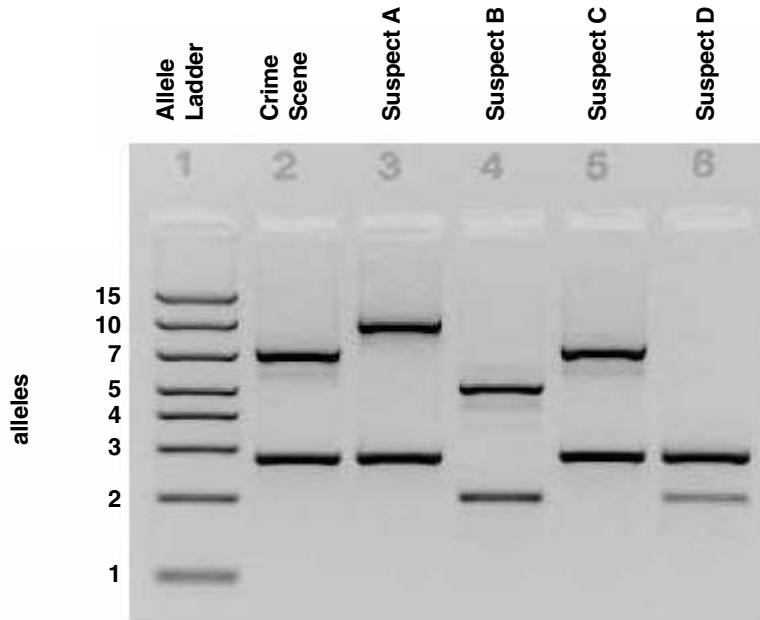

Fig. 8. Representative results from Crime Scene Investigator PCR Basics kit following PCR amplification, gel electrophoresis and gel staining.

The sample in lane 2, the Crime Scene DNA, has two alleles: 7 and 3. The genotype of the Crime Scene DNA is then 7-3 (or 3-7). The genotype of the next sample is 10-3, the next sample is 5-2, and so on. A summary of the alleles identified and the genotypes obtained is in the table below:

Lane of gel	DNA sample	genotype (identified alleles)
1	Allele Ladder	N/A
2	Crime Scene	7-3 (allele 7 + allele 3)
3	Suspect A	10-3 (allele 10 + allele 3)
4	Suspect B	5-2 (allele 5 + allele 2)
5	Suspect C	7-3 (allele 7 + allele 3)
6	Suspect D	3-2 (allele 3 + allele 2)

The final step in the experiment is to examine the results and determine whether there is a match between the Crime Scene DNA and any of the DNA samples obtained for analysis for the investigation. Samples that don't match the Crime Scene DNA can be excluded from the investigation; samples that do match the Crime Scene DNA are included as part of the suspect pool.

Quick Guide

Lesson 1: Setting up the PCR Reactions

1. Label 5 PCR tubes CS, A, B, C, or D, and include your group name or initials as well. Place each PCR tube into a capless micro centrifuge tube in the foam float on ice.

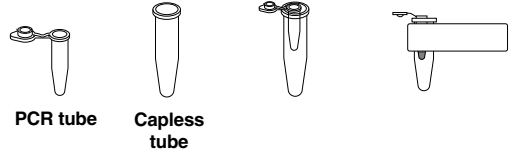

2. Using the chart below as a guide, transfer 20 µl of the appropriate template DNA into the correctly labeled tube. **Important: use a fresh aerosol barrier pipet tip for each DNA sample.**

Label PCR tubes	Add DNA template	Add Master mix + primers
CS + your initials	20 µl Crime Scene DNA	20 µl MMP (blue)
A + your initials	20 µl Suspect A DNA	20 µl MMP (blue)
B + your initials	20 µl Suspect B DNA	20 µl MMP (blue)
C + your initials	20 µl Suspect C DNA	20 µl MMP (blue)
D + your initials	20 µl Suspect D DNA	20 µl MMP (blue)

3. Transfer 20 µl of the blue MMP (master mix + primers) into each of the 5 PCR tubes containing template DNA. Pipet up and down to mix. Cap each tube after adding blue MMP. **Important: use a fresh aerosol barrier pipet tip each time. Immediately cap each tube after adding MMP.**

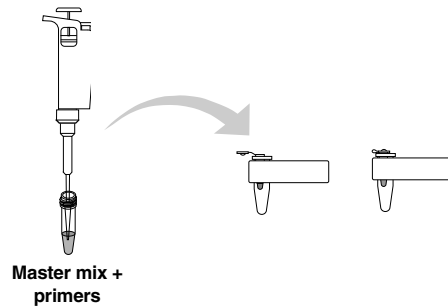

4. Place your capped PCR tubes in their adaptors on ice.

5. When instructed to do so, place your tubes in the thermal cycler. Your instructor will program the thermal cycler for PCR.

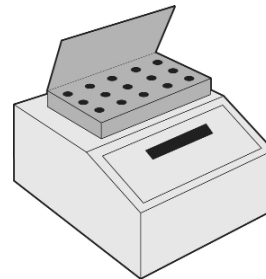

Lesson 2: Electrophoresis of PCR Products

1. Set up your gel electrophoresis equipment as instructed.
2. Obtain your 5 PCR tubes from the previous lesson. Place your PCR tubes in capless tubes and pulse-spin in a balanced microcentrifuge for a few seconds to collect all liquid to the bottom of the tube.
3. Transfer 10 μl of Orange G loading dye (from the tube labeled 'LD') into each of your PCR tubes. Pipet up and down to mix, and pulse-spin to collect liquid in the bottom of the tube.
4. Place an agarose gel in the electrophoresis apparatus. Check that the wells of the agarose gel are near the black (-) electrode and the base of the gel is near the red (+) electrode.
5. Fill the electrophoresis chamber with enough 1x TAE buffer to cover the gel. This will require ~275 ml of 1x TAE buffer.
6. Using a clean tip for each sample, load 20 μl of the samples into 6 wells of the gel in the following order:

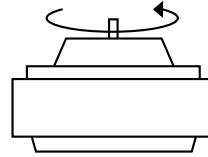

Centrifuge

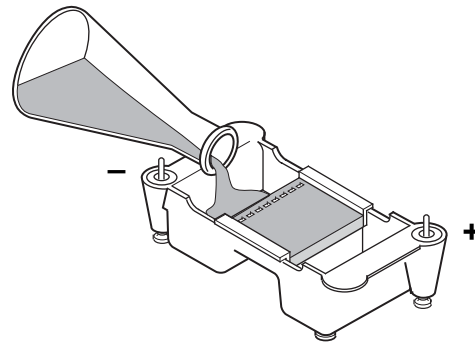

Lane	Sample	Load volume
1	Allele Ladder	20 μl
2	Crime Scene	20 μl
3	Suspect A	20 μl
4	Suspect B	20 μl
5	Suspect C	20 μl
6	Suspect D	20 μl

7. Secure the lid on the gel box. The lid will attach to the base in only one orientation: red to red and black to black. Connect the electrical leads to the power supply.
8. Turn on the power supply and electrophorese your samples at 100 V for 30 minutes.
9. Stain in Fast Blast DNA stain. Refer to the Student Manual for specific instructions.

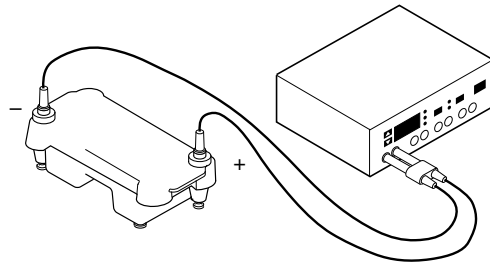

Student Manual

Crime Scene Investigator PCR Basics Kit

You are about to conduct real world forensic DNA profiling. As a crime scene investigator, you will use the polymerase chain reaction (PCR) and agarose gel electrophoresis to analyze the DNA samples obtained from a hypothetical crime scene and four suspects. Your job is to identify the perpetrator. In this analysis, a genotype is the particular set of genetic markers, or alleles, in a DNA sample. Every person's genotype is their own uniquely personal genetic barcode. In this experiment, you'll be revealing the genetic barcodes of several individuals, and looking for a match.

How can DNA evidence solve crimes?

DNA profiling refers to the use of molecular genetic methods used to determine the genotype of a DNA sample. This powerful tool is routinely used around the world for investigations of crime scenes, missing persons, mass disasters, human rights violations, and paternity. Crime scenes often contain biological evidence (such as blood, semen, hairs, saliva, bones, pieces of skin) from which DNA can be extracted. If the DNA profile obtained from evidence discovered at the scene of a crime matches the DNA profile of a suspect, this person is included as a potentially guilty person; if the two DNA profiles do not match, the individual is excluded from the suspect pool.

A Brief History of Forensic Analysis

Forensic sciences describe the boundary between science and the law. Forensic science can as easily convict someone of a crime as free someone wrongly convicted. The earliest uses of forensic science for criminal investigations involved the use of photographs to document crime scenes. Fingerprint evidence has been in use for the past 100 or so years. The first genetic evidence to be collected for investigative work involved the use of blood group typing. The 1980's saw the first use of a DNA-based forensic test, restriction fragment length polymorphism analysis, or RFLP. Although RFLP analysis has its limitations, it has been the workhorse of forensic analysis for nearly 20 years. Only with the recent advent of PCR has this aspect of the criminal justice system become truly modernized. Modern forensic DNA profiling makes it possible to distinguish any two people on the planet (with the exception of identical twins), living or dead.

PCR is DNA replication gone crazy in a test tube

PCR produces large amounts of a specific piece of DNA from trace amounts of starting material (template). The template can be any form of double-stranded DNA. A researcher can take trace amounts of DNA from a drop of blood, a single hair follicle, or a cheek cell and use PCR to generate millions of copies of a desired DNA fragment. In theory, only a single template strand is needed to generate millions of new DNA molecules. Prior to PCR, it would have been impossible to do forensic or genetic studies with this small amount of DNA. The ability to amplify the precise sequence of DNA that a researcher wishes to study or manipulate is the true power of PCR.

One of the main reasons PCR is such a powerful tool is its simplicity and specificity. The specificity of PCR is its ability to target and amplify one specific segment of DNA a few hundred base pairs in length out of a complete genome of over 3 billion base pairs. In addition, all that is required for PCR is at least one DNA template strand, DNA polymerase, two DNA primers, and the four nucleotide building block subunits of DNA – A, G, T, and C – otherwise known as the deoxynucleotide triphosphates of adenine, guanine, thymine, cytosine, and reaction buffer.

PCR allows forensic scientists to reveal personal details about an individual's genetic makeup and to determine the most subtle differences in the DNA of individuals - from the tiniest amount

of biological material. The fact that millions of exact copies of a particular DNA sequence can be produced easily and quickly using PCR is the basis for modern forensic DNA testing.

What kinds of human DNA sequences are used in crime scene investigations? There are ~3 billion basepairs in the human genome – greater than 99.5% do not vary between different human beings. However, a small percentage of the human DNA sequence (<0.5%) does differ, and these are the special **polymorphic** ("many forms") sequences used in forensic applications. By universal agreement, DNA sequences used for forensic profiling are "anonymous"; that is, they come from regions of our chromosomes (also called **loci**) that do not control any known traits and have no known functions. Loci are basically genetic addresses or locations. A single **locus** may have different forms or types; these different forms are called **alleles**. A locus may be bi-allelic, having only two different forms, or it may be polymorphic, as described above.

The DNA sequences used in forensic labs are non-coding regions that contain segments of **Short Tandem Repeats** or **STRs**. STRs are very short DNA sequences that are repeated in direct head-to-tail fashion. The example below shows a locus (known as TH01) found on chromosome 11; its specific DNA sequence contains four repeats of [TCAT].

..CCCTCATTTCATTTCATTTC A..

For the TH01 STR locus, there are many alternate polymorphic alleles that differ from each other by the number of [TCAT] repeats present in the sequence. Although more than 20 different alleles of TH01 have been discovered in people worldwide, each of us still has only two of these, one inherited from our mother and one inherited from our father. For example as shown in figure 9, suspect A has one allele with 6 repeats, and one allele with 3 repeats, giving a DNA profile for the TH01 locus of 6-3.

Suspect A's DNA type for the TH01 locus is (5–3)		Suspect B's DNA type for TH01 locus is (6–10)	
C C C □ □ □ □ □ A A A	5*	C C C □ □ □ □ □ □ □ A A A	6*
C C C □ □ □ A A A	3*	C C C □ □ □ □ □ □ □ □ □ □ □ □ □ A A A	10*

* Number of [TCAT] repeats

Fig. 9. Two sample TH01 genotypes.

How are STR alleles detected?

The key to DNA profiling is amplification of the copies present in the small amounts of evidentiary DNA by **polymerase chain reaction (PCR)**. Using primers specific to the DNA sequences on either side of the [TCAT] STR, billions of copies of each of the two original TH01 alleles in any one person's DNA type are synthesized in the reaction. These copies contain the same number of STRs present in the original DNA copies and can be visualized using agarose gel electrophoresis. By comparison with a DNA size standard, or allele ladder, that corresponds to the known sizes of TH01 alleles, the exact sizes of the PCR products from the sample DNAs can be determined and compared.

A diagram of the results for TH01 typing of Suspect A and Suspect B is shown in figure 10. In this cartoon example, PCR has been performed on DNA from 2 suspects using primers specific for the TH01 locus. Following gel electrophoresis which separates the PCR products according to their size, the pattern of bands is compared to the Allele Ladder to identify the alleles present in the original samples.

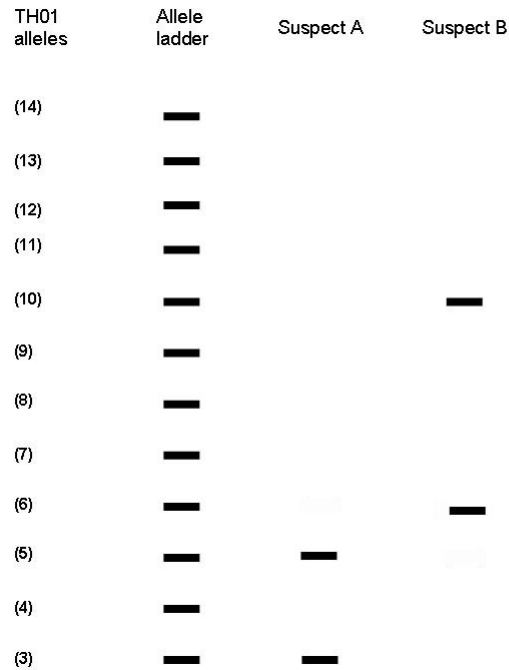

Fig. 10. Illustration of sample TH01 genotypes following gel electrophoresis.

Imagine a scenario in which Suspect A and Suspect B are accused of being involved in a love triangle and committing the murder of a third person in the Highway Motel; the person who actually pulled the trigger is unknown (for more information on this scenario, see the next page). In addition to DNA samples from the crime scene, the forensic specialist will isolate DNA from suspects, victims, and any others present to genotype as controls. Using PCR-based analysis, the samples will be examined at 13 different genetic locations, or loci, using software to interpret the results from the amplification products. In real crime scene analysis, DNA profiling is performed at many loci to improve the **power of discrimination** of the testing. In simple terms, the power of discrimination is the ability of the profiling to tell the genetic difference between different individuals. The larger the number of loci profiled, the more powerful the ability to discriminate.

Imagine the following scenario:

Scene: The Highway Motel, #1 Dark Highway, Nowhere

Setting: Room #13.

The motel manager hears loud voices, a woman screams, and a shot rings out. The manager runs to the window in time to see the receding lights of a car leaving in a hurry. The door to room # 13 hangs open. The manager runs to the open door, to see a man lying face down in a pool of blood. He calls 911. The police arrive, and begin to examine the crime scene. An apparent homicide, but with no obvious clues as to who committed the crime. Or...?

A forensic specialist is called in to examine the crime scene and collect evidence. Even though it looks like the people involved left no evidence behind, the specialist can use laboratory tests that can tell who was at the crime scene from a single drop of blood or a lone hair. Is this a science fiction story, or reality?

Very much a reality. Testing is routinely done in forensic testing labs across the US and in many other parts of the world from only a single cell, and sometimes from samples that are decades old. The reason this is possible is because of DNA. To be able to perform laboratory tests, the specialist needs biological material to work with. Often, there is very little material left at the scene of a crime, and not in quantities that will allow analysis. To get around this problem, the specialist takes advantage of a process that each and every cell in your body uses to divide.

The most important part of any cell's life is when it commits to reproducing itself and dividing. The basic result of any cell division is the creation of two identical daughter cells from one original cell. To ensure that this happens, DNA replication must have a high degree of specificity and accuracy, that is, it must copy DNA exactly. To do so, the enzymes involved in DNA replication use the information already contained in the existing strands to make new DNA copies. This basic idea - the exact copying of DNA from a template - is the basis for a new technology that has revolutionized many areas of science, medicine, and the courts.

PCR allows the forensic specialist to specifically amplify, or copy, any region of DNA that he or she is interested in. PCR is the basis for DNA testing that is currently used in nearly all forensic analysis.

In this experiment, you will perform PCR analysis on a single locus, the BXP007 locus, using template DNAs obtained from a simulated crime scene and a victim. Following PCR, you will run an agarose gel to separate the PCR products, visualize the PCR products, compare them to a simulated ladder of possible alleles for this locus, and assign a genotype for the templates. You will then look to see if any of the suspects' genotype match the crime scene, and see whether you can determine whodunit!

Let's examine the DNA evidence and find out who pulled the trigger.

Student Questions – Introduction

1. What kinds of materials obtained from a crime scene might contain DNA?
2. Why do you need to perform PCR on DNA obtained from a Crime Scene?
3. What might you see if you ran a DNA sample extracted from evidence on a gel before PCR?
4. What is a genotype?
5. What is the difference between an allele and a locus?
6. Why do forensic labs analyse non-coding DNA and not genes?

Lesson 1 PCR Amplification

PCR amplification is DNA replication in a test tube. The portion of the DNA you want to make copies of is called the target sequence. The sample of DNA obtained at a crime scene and the suspect's DNA samples contain the target sequence.

PCR relies on three principles of molecular biology

1. Denaturation - melting double stranded DNA template into single strands
2. Annealing - complementary DNA strand hybridization via DNA primers
3. Extension - DNA strand synthesis via DNA polymerase

Denaturation. Before new DNA synthesis can begin the double stranded DNA template must be unwound and separated into single strands. In cells this is carried out by a family of enzymes. In PCR, heat is used to melt apart – or **denature** – the double stranded DNA template.

Annealing. Before a target region of DNA can be amplified, one must determine short sequences of DNA upstream (at the 5' end) and downstream (at the 3' end) of the target loci region of interest. These areas are then used to make short pieces of DNA, called primers or oligonucleotides, which are complementary to regions upstream and downstream of the target loci region (Figure 11). Primers serve as start and stop points for amplifying the target region of the DNA to be copied.

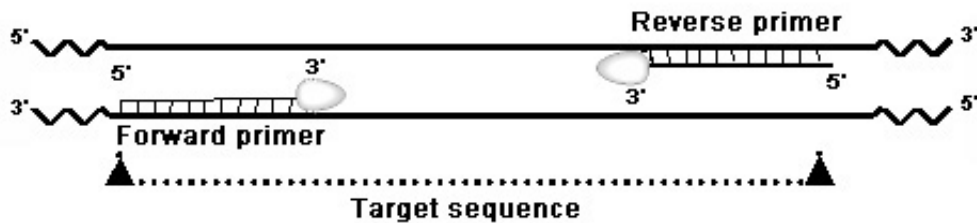

Fig. 11. Primers annealed to a target DNA sequence during PCR.

In PCR, complementary strand hybridization takes place when oligonucleotide primers anneal, or bind, to their respective complementary base pair sequences on the template. Hybridization is the process that describes the binding of the oligonucleotide primer to the template DNA. The two strands anneal to each other, forming a 'hybrid'. Like bookends, the two primers are designed and synthesized in the laboratory with a specific sequence of nucleotides so they will anneal at the opposite ends and on the opposite strands bracketing the target stretch of double-stranded DNA (template strand) to be amplified. Therefore, the target sequence is determined by the location that the primers anneal to.

Extension. Primers are needed because the **DNA polymerase** requires an already existing nucleotide chain to bind and add nucleotides to one at a time. Once the polymerase locates and binds to template DNA and the primer, it initiates the addition of nucleotides and synthesizes new copies of the double stranded template DNA by adding nucleotides onto the primer and extending it. Therefore, primers provide a starting point for the DNA polymerase.

These 3 steps – denaturation, annealing, and extension together make up one PCR cycle. A complete PCR reaction involves many repetitions of a single PCR cycle. In this experiment, your PCR reactions will cycle 35 times.

The enzyme used in PCR – **DNA polymerase** – must be thermally stable because PCR cycles between temperatures of 52°C and 94°C. The thermostable DNA polymerase that performs the polymerization was isolated from a thermophilic bacterium, *Thermus aquaticus* (*Taq*), which lives in high-temperature steam vents such as those found in Yellowstone National Park.

Two template strands are created from the original template after each complete cycle of the strand synthesis reaction – denaturation, annealing, and extension. It is called the polymerase chain reaction because exponential growth of the number of template molecules occurs after each cycle is complete, i.e., the number of DNA copies doubles at each cycle. Therefore, after 35 cycles there will be 2^{35} times more copies than at the beginning. After 35 cycles, the DNA of interest has been amplified sufficiently to be visualized using gel electrophoresis and DNA stains. This allows researchers to determine the presence or absence of the desired PCR products.

In order for PCR to happen efficiently, several components are needed. In addition to the template, the oligonucleotide primers, and the enzyme (*Taq* DNA polymerase), a special reaction buffer is also required, called a **master mix**. The master mix contains all of the components for PCR to occur, including the individual building blocks of DNA (nucleotides, or dNTPs), a special buffer to maintain optimum pH, salts, and $MgCl_2$. Salts and magnesium ions (also known as cofactors) are needed for the *Taq* DNA polymerase to perform optimally. In this experiment, your instructor will provide you with a master mix that comes prepared with all of the ingredients listed above, but also includes colored primers and *Taq* polymerase mixed in. For this reason, it's important to keep the master mix cold before use, so that the enzyme doesn't start to work before you add your DNA templates.

In this part of the experiment, you will obtain DNA samples which have been collected from a crime scene and four individuals suspected of being involved in the crime. Your task is to amplify the region of interest (the BXP007 locus, a polymorphic allele) from the DNA samples. Once complete, you will analyze your PCR products using gel electrophoresis to determine the genotypes of the samples at the BXP007 locus and match the crime scene DNA to one of the suspects.

Student Questions: Lesson 1

PCR Student Questions

1. What does PCR allow you to do with DNA?
2. What components do you need to perform PCR?
3. What is in the master mix and why do you need each component?
4. Why do you need to perform PCR on DNA evidence from a crime scene?
5. What steps make up a PCR cycle, and what happens at each step?

Student Protocol – Lesson One

Student Workstations

Material	Quantity
Ice bath containing tubes of DNA (as below)	1
Master Mix + primers (MMP, blue liquid)	1
Crime Scene and Suspect A - D DNAs	5 (one of each tube indicated)
PCR tubes	5
PCR adaptors	5
Foam float	1
Marking pen	1
2–20 μ l adjustable micropipet or fixed volume 20 μ l micropipet	1
2–20 μ l pipet tips, aerosol barrier	1 rack

- You will have 6 tubes in a white foam rack on ice, and 5 x 0.2 ml PCR tubes in a rack at your workstation.

In the ice, you should have -

One yellow tube labeled MMP containing blue liquid.

5 tubes labeled CS (purple tube), A (green tube), B (blue tube), C (orange tube), and D (pink tube).

Label PCR tubes CS, A, B, C, and D and include your group name or initials as well.

The labels correspond to the following tube contents:

PCR tubes labelled	DNA templates	Master mix + primers (blue liquid)
CS + your initials	20 μ l Crime Scene DNA (purple tube)	20 μ l MMP (yellow tube)
A + your initials	20 μ l Suspect A DNA (green tube)	20 μ l MMP (yellow tube)
B + your initials	20 μ l Suspect B DNA (blue tube)	20 μ l MMP (yellow tube)
C + your initials	20 μ l Suspect C DNA (orange tube)	20 μ l MMP (yellow tube)
D + your initials	20 μ l Suspect D DNA (pink tube)	20 μ l MMP (yellow tube)

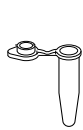

PCR tube



Capless tube

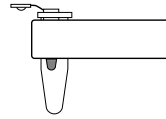

- Keep tubes on ice during the procedure.
- Using aerosol barrier pipet tips and either an adjustable micropipet set to 20 μ l, or a fixed-volume 20 μ l micropipet, add 20 μ l DNA to each tube as indicated in the table above. For example, for the Crime Scene DNA, transfer 20 μ l of the template into your 'CS' labeled PCR tube. **Important: use a fresh pipet tip for each DNA.**
- Using aerosol barrier pipet tips and either an adjustable micropipet set to 20 μ l, or a fixed-volume 20 μ l micropipet, add 20 μ l of the Master Mix + primers to each tube as indicated in the table above. Mix the contents of your PCR tubes by gently pipetting up and down. **Important: use a fresh pipet tip each time.** Once you've added MMP to a tube, close the cap. The solution in your PCR tubes should be blue. If it's not blue, talk to your instructor.

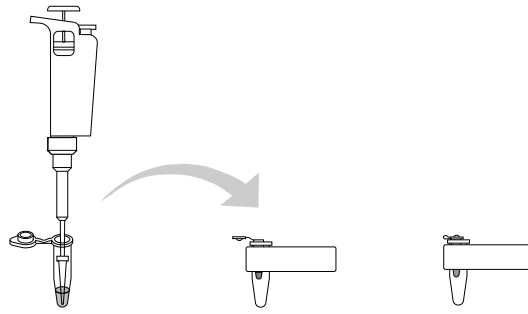

Master mix + primers (MMP)

5. Place your capped PCR tubes in their adaptors on ice. You can remove the template DNA tubes to make room for your PCR tubes.
6. When instructed to do so, place your tubes in the thermal cycler.

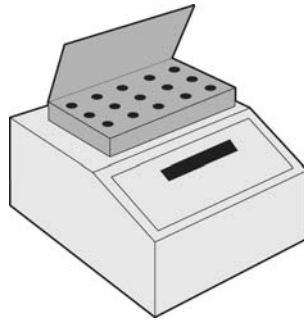

Lesson Two Electrophoresis of PCR Products

You have completed your PCR amplification. However, at this point, you can't actually tell whether or not you have PCR products. To do this, you must sort your PCR products using gel electrophoresis and then visualize them using a DNA stain. Since DNA is negatively charged, it can be separated using an electric current. In fact, electrophoresis means "carry with current". In agarose gel electrophoresis, DNA is placed in solidified agarose, which forms sieves containing pores that vary in size depending on the concentration of the agarose. The higher the concentration of agarose, the smaller the pore size, and the longer it takes for larger molecules to move through. This is particularly useful when you want to compare DNA molecules of different sizes contained in the same sample. Movement through the gel occurs when an electric current is applied across the gel. Since the gel is immersed in buffer, the current will travel through the buffer and gel, carrying the negatively charged DNA with it toward the positive anode.

In addition to your PCR products, you will also be running a DNA Allele Ladder that represents all of the possible alleles at the BXP007 locus. This is a reference, or marker, that you can compare your PCR reactions to so you can judge their relative sizes and their identities. In the following drawing of a gel, the samples, or bands, seen in the first track, or lane, all come from the BXP007 Allele Ladder. These are the standard sizes of all the alleles known to occur at this locus. There are 8 possible alleles, with the largest at the top of the gel and the smallest at the bottom. The sizes are, from top to bottom, 1500, 1000, 700, 500, 400, 300, 200, and 100 base pairs (bps). Allele names are indicated in the figure. In the next several lanes, we see PCR products that come from DNA samples that have been tested for what alleles they carry at this particular locus. As shown in figure 12, the sample in the lane next to the Allele Ladder, the Crime Scene Sample (CS) has a genotype that corresponds to alleles 5 and 2 on the allele ladder. We would say that the genotype for this sample is 5-2. For the next sample, the genotype would be 7-4, and so on.

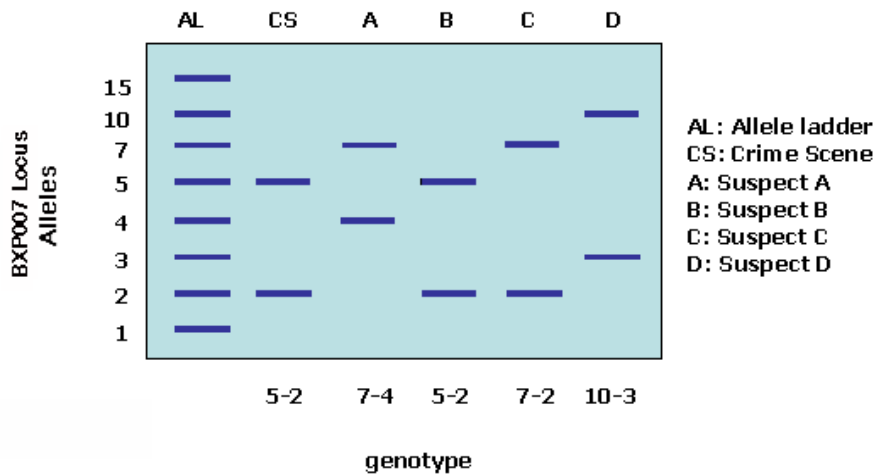

Fig. 12. A cartoon of potential Crime Scene Investigator PCR Basics kit results at the BXP007 locus.

Student Protocol – Lesson Two

Student Workstation

Material	Quantity
3% agarose gel	1
PCR Samples from previous lab	5
1X TAE running buffer	300–350 ml
Orange G loading dye (LD; orange liquid)	60 μ l
Crime Scene Investigator Allele Ladder (orange liquid)	25 μ l
Note: Don't confuse these two tubes of orange liquid. They contain different compounds.	
2–20 μ l adjustable volume pipet or fixed volume 20 μ l micropipet	1
1–20 μ l pipet tips, aerosol barrier	1 rack
Gel electrophoresis chamber (may be shared by 2 workstations)	1
Power supply (may be shared by multiple workstations)	1
Fast Blast DNA stain (at common workstation)	1
Gel staining tray	1

Protocol

1. Set up your gel electrophoresis apparatus as instructed.
2. Obtain your 5 PCR reactions from the previous lesson, place them into a capless tube adaptor, and place both tubes into the foam float or a rack.
3. Using aerosol barrier pipet tips and either an adjustable micropipet set to 10 μ l, or a fixed-volume 10 μ l micropipet, add 10 μ l of Orange G loading dye (from the tube labeled 'LD') to each PCR reaction tube and mix well. **Important: use a fresh tip each time.**
4. Using the table below as a guide, load 20 μ l of the allele ladder and 20 μ l each sample into your gel in the order indicated below.

Lane	Sample	Load volume
1	Allele Ladder	20 μ l
2	Crime Scene	20 μ l
3	Suspect A	20 μ l
4	Suspect B	20 μ l
5	Suspect C	20 μ l
6	Suspect D	20 μ l

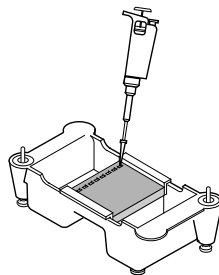

5. Run your gel at 100 V for 30 minutes. Do not let the orange dye front migrate out of the gel.

6. Stain in Fast Blast DNA stain as directed by your instructor and described below.

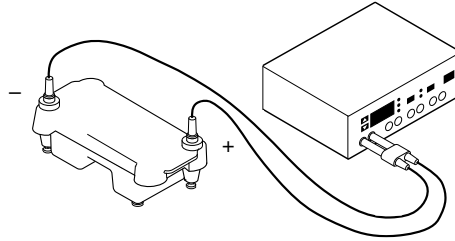

Staining of Agarose Gels

1. When electrophoresis is complete, turn off the power and remove the lid from the gel box. Carefully remove the gel tray and the gel from the gel box. Be careful, **the gel is very slippery**. Nudge the gel off the gel tray with your thumb and carefully slide it into a container for staining.

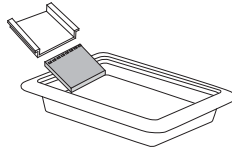

2. There are two protocols for staining your gel. Your instructor will inform you which one you will use.

Protocol 1: Overnight staining (Recommended)

- a. Add 120 ml of 1x Fast Blast DNA stain to your staining tray (2 gels per tray).

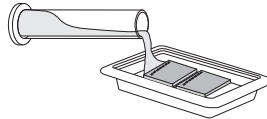

- b. Let the gels stain for approximately 4–24 hours with gentle shaking for best results. No destaining is required.

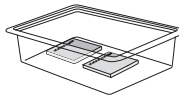

- c. The next day, pour off the stain into a waste beaker.
- d. Place the gel on a light background and record your result. With a permanent marker, trace the wells and band patterns onto a clear sheet of plastic or acetate sheet.

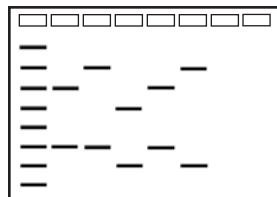

- f. Trim away any empty lanes of the gel with a knife or razor blade.
- g. To obtain a permanent record, air-dry the gel between cellophane sheets (your instructor will show you how). Tape the dried gel into your lab notebook. Avoid exposure of the stained gel to direct light, since it will cause the bands to fade.

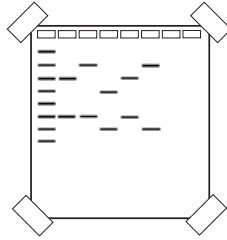

Protocol 2: Quick staining (requires approximately 20 minutes) – This method will allow you to see bands quickly (within 15 minutes), but may require extensive destaining to obtain optimal band-to-background intensity. **Note:** it is important to use warm tap water for the destaining steps of this protocol.

- a. Immerse your gel in 100x Fast Blast.

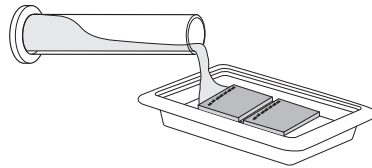

- b. Stain the gel for 5 minutes with gentle agitation. Save the used stain for future use. Stain can be reused at least 7 times.
- c. Transfer the gels into a large washing container and rinse with **warm** (40–55°) tap water for approximately 10 seconds.
- d. Destain by washing three times in **warm** tap water for 5 minutes each, with gentle shaking for best results. You should be able to see bands after 10 minutes with light coming up through the bottom of the staining tray. If necessary, keep destaining in warm water until the desired contrast is reached.

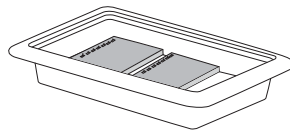

- e. Place the gel on a light background and record your result. With a permanent marker, trace the wells and band patterns onto a clear sheet of plastic or acetate sheet.

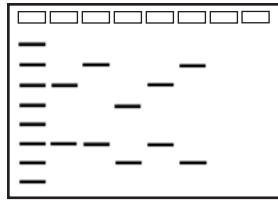

- g. Trim away any empty lanes of the gel with a knife or razor blade.

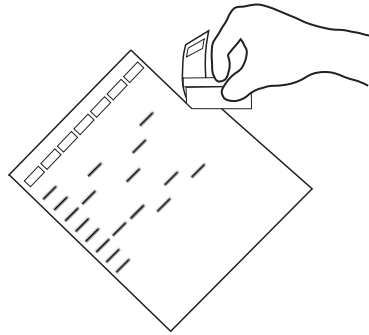

- h. To obtain a permanent record, air-dry the gel on cellophane sheets (your instructor will show you how). Tape the dried gel onto your lab notebook. Avoid exposure of the stained gel to direct light, since it will cause the bands to fade.

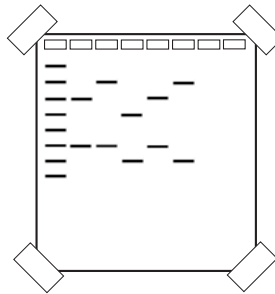

Lesson 3: Drying Gels and Analysis of Results

For a permanent record of the experiment, gels can be dried between cellophane sheets and then inserted into lab notebooks. To analyze the wet gels, gels can be scanned, photocopied (a yellow backing improves contrast) or traced onto acetate film. There are 2 methods for drying gels. Please note that agarose gel support film does not work effectively for 3% gels.

GelAir drying frame method

Materials needed for drying gels using the GelAir dryer	Quantity
Cellophane sheets	4
GelAir assembly table	1
GelAir drying frame	2
GelAir clamps	16
GelAir Dryer (optional)	1
Distilled water	500 ml

Procedure

- Step 1: Prewet 2 sheets of cellophane in a container of water for 15–20 seconds.
- Step 2: Place a plastic drying frame on the GelAir assembly table. Center one sheet of cellophane on the assembly table.
- Step 3: Carefully lay your gel on the cellophane, positioning it to accommodate other gels (up to 6 total). If there are bubbles between the gel and the cellophane, gently push them out with your gloved finger.
- Step 4: Flood the gels with water and lay the second sheet of cellophane on top of them. If you are drying polyacrylamide gels, try not to trap any bubbles in the sandwich since bubbles will cause cracks in the gel during drying. If there are any bubbles, gently push them out with a gloved finger. You cannot avoid bubbles at the edges of agarose gels since they are so thick, but avoid bubbles between the cellophane and the face of the gel.
- Step 5: Place the square metal frame on top of the cellophane sandwich. Secure the eight clamps onto the frame, two on each side. If you are not using a GelAir dryer oven, place the frames upright in a well-ventilated area for 12–36 hours. If you have a GelAir dryer, place up to four drying frames into the oven, turn the heater switch on and set the dial to 3 hours. The dryer will shut off automatically.
- Step 6: When the gels are completely dry, they will be flat. Remove the clamps and take the gel/cellophane sandwich from the frame. Trim the excess cellophane surrounding your dried gel with scissors.

Cellophane sandwich and plastic container method

Materials needed for drying gels using plastic containers

	Quantity per student workstation
Cellophane sheets	2
Plastic container–Tupperware-type (minimum 6 x 6" opening)	1
Rubber bands	2
Distilled water	500 ml

Procedure

- Step 1: Wet two pieces of cellophane in a large volume of water, approximately 500 ml.
- Step 2: Place one sheet of cellophane over a plastic container. Pull the cellophane taut so that it makes a flat surface over the top of the container, and use a rubber band to secure the sheet in place.
- Step 3: Place a gel onto the cellophane. Remove any air bubbles that are under or around the gel. Flooding the surface of the cellophane around the gel with water will aid in the removal of bubbles.
- Step 4: Place the second sheet of wetted cellophane over the gel, being careful not to trap any bubbles. Secure the second sheet of cellophane to the box with a second rubber band.
- Step 5: Allow gel to dry for several days in a well-ventilated area.

Analysis of results

Although it is possible to analyze the dried gels, be aware that higher percentage agarose gels may be difficult to dry flat. In addition, exposure of the stained gel to light will cause the stain to fade. It is therefore recommended that analysis and determination of genotypes be done on wet gels.

Once the gels have been stained with Fast Blast DNA stain, it is time to determine the alleles present in each sample, and assign a DNA profile (genotype). For each PCR reaction, compare the bands obtained in each lane to the Allele Ladder run in lane #1. See page 40 for representative results, sizes of the ladder bands, and labeling of the alleles in the ladder. Assign each band in each PCR reaction with an allele assignment according to the band of corresponding size in the allele ladder. The bands in the allele ladder are numbered from top to bottom starting with the largest allele, #15, at the top. The sizes of the bands are indicated in the table below. In the example shown in figure 8 (page 26), the allele assignment for the sample in lane 2 is 3-7, since there is one allele 7 and one allele 3 in that lane. Write down the genotype for each of your samples in the chart below.

Lane	Sample	Number of Bands?	What BXP007 alleles are present?
1	BXP007 Allele Ladder		
2	Crime Scene DNA		
3	Suspect A DNA		
4	Suspect B DNA		
5	Suspect C DNA		
6	Suspect D DNA		

1. Did your samples all generate PCR products? If not, give reasons to explain why.

2. What is the genotype of each of your samples?

3. Does the Crime Scene DNA sample have a genotype that matches any of the suspects? If so, which one matches?

4. What does this result tell you about which suspects are included in the investigation? excluded? Explain your answer.

5. Imagine that each allele at the BXP007 locus is found at exactly the same frequency in a population. Since there are 8 possible alleles at the BXP007 locus, what is the frequency of any one allele from this locus in this population?

6. Given Mendel's Law of Independent Assortment and the assumption above, what is the frequency of the genotype of the Crime Scene sample?

7. If you had a pool of 13 suspects, and only one suspect had a genotype that matched the BXP007 locus found at the crime scene, would you be satisfied that you had identified the perpetrator based only on the genotype frequency calculated for the BXP007 locus? Why or why not? Explain your answer.

Appendix A

DNA and PCR in detail

DNA: A Detailed Look

A DNA molecule is a long polymer consisting of four different components called **nucleotides**. It is the various combinations of these four bases or nucleotides that create a unique DNA code or sequence (also genotype, gene, and allele).

Nucleotides are comprised of three different components:

- **Nitrogen base**
- **Deoxyribose sugar**
- **Phosphate group**

Each nucleotide contains the same ribose sugar and the phosphate group. What makes each nucleotide unique is its nitrogen base. There are four nitrogen bases:

Adenine (A)
Thymine (T)
Guanine (G)
Cytosine (C)

A DNA nucleotide chain is created by the connection of the phosphate group to the ribose sugar of the next nucleotide. This connection creates the “backbone” of the DNA molecule. To designate the different ends of this single-stranded chain, biochemistry terminology is used, in which the carbons on any sugar group are numbered. The sugar of a nucleotide contains 5 carbons. The phosphate group (PO_4) of a given nucleotide is connected to the 5' carbon of the sugar. A hydroxyl group (OH) is attached to the 3' carbon of the sugar, and this 3' OH group connects to the phosphate group of the next nucleotide in the chain.

Thus, the end of a single-strand DNA molecule that has a free phosphate group (i.e., not attached to another nucleotide) is called the 5' end, and the end of the DNA molecule with a free hydroxyl group (with no subsequent nucleotide attached) is called the 3' end (see Figures 13 and 14).

It has become standard that a single-stranded DNA molecule is written with the 5' end on the left and the 3' end on the right. Therefore, a single-stranded DNA chain's sequence is represented from left to right, starting on the left with the 5' nucleotide and moving to the right until the 3' nucleotide is last. Most DNA sequences are read 5' to 3'.

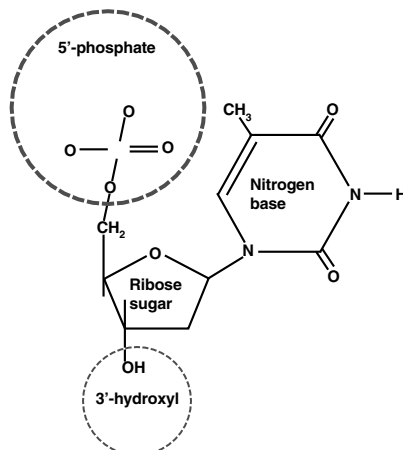

Fig. 13. Structure of one nucleotide of deoxyribonucleic acid.

The long DNA molecules or chains that comprise the chromosomes are not single-stranded molecules. From X-ray crystallography patterns of DNA generated by Rosalind Franklin, and some imaginative molecular model building, Watson and Crick deduced that DNA is in fact a **double-stranded** molecule with the two single strands of DNA held together by **hydrogen bonds** between the nitrogen bases (A, T, G, and C). This double-stranded molecule is often called a duplex (Figures 14 and 15). There are several important properties of double-stranded DNA molecules:

- Chromosomal (also called genomic) DNA is double-stranded
- The overall structure is that of a helix with two strands intertwined
- The structure can be viewed as a twisted ladder
- The phosphate-deoxyribose backbones are the sides of the ladder
- The nitrogen bases (A, T, G, and C) hydrogen bonded to each other are the rungs
- Only the nitrogen bases A & T and C & G can form hydrogen bonds to each other. When A binds to T or C binds to G this is considered **base pairing**. Neither C and T, nor A and G form hydrogen bonds
- The two strands are antiparallel; that is, the strands are oriented in opposite directions. This means that the ladder runs 5' to 3' in one direction for one strand and 5' to 3' in the opposite direction for the other strand

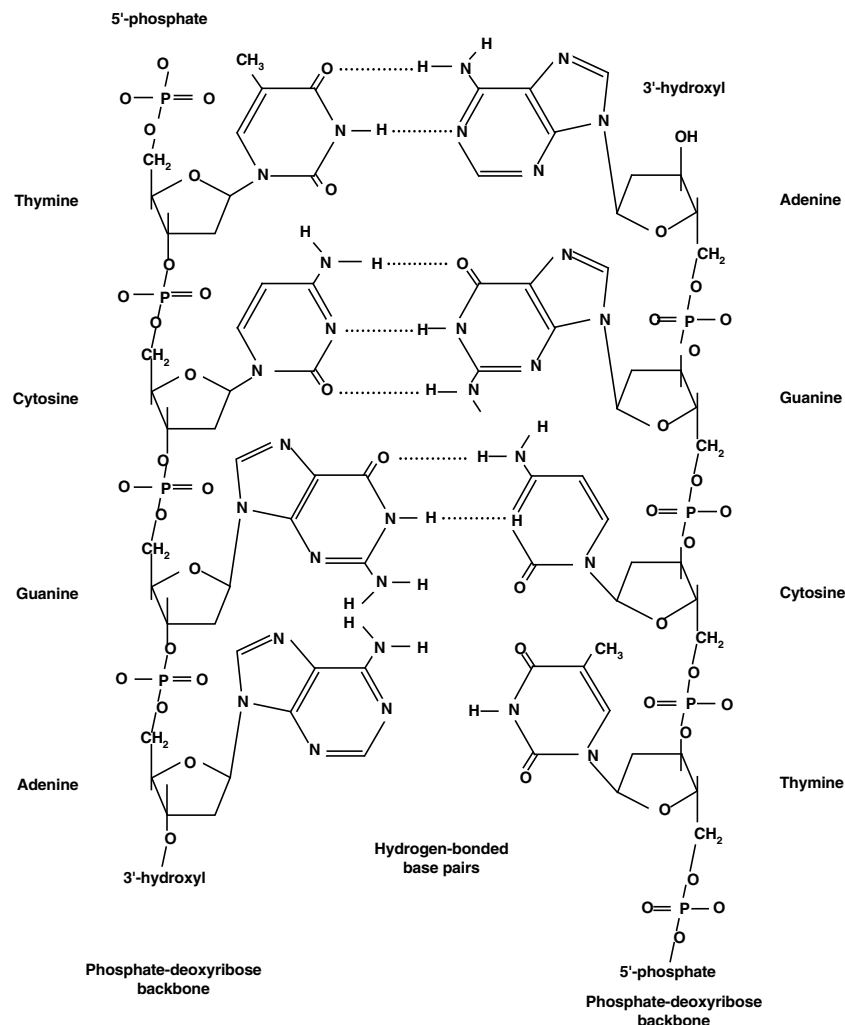

Fig. 14. Molecular structure of a portion of a double-stranded DNA molecule.

DNA Structure Conclusions

- Because A only binds to T, and G only binds to C, the two strands will have exactly the opposite, or complementary, sequence running in opposite directions (one strand 5' to 3' in one direction, the other 5' to 3' in the other direction).
- These two complementary strands anneal or hybridize to each other through hydrogen bonds between the bases.
- A new strand of DNA can be synthesized using its complementary strand as the template for new synthesis.
- Each strand carries the potential to deliver and code for information.

The length of any double-stranded DNA molecule is given in terms of base pairs (bp). If a DNA strand contains over a thousand base pairs, the unit of measure is kilobases (1 kb = 1,000 bp). If there are over one million base pairs in a strand the unit of measure is megabases (1 Mb = 1,000 kb).

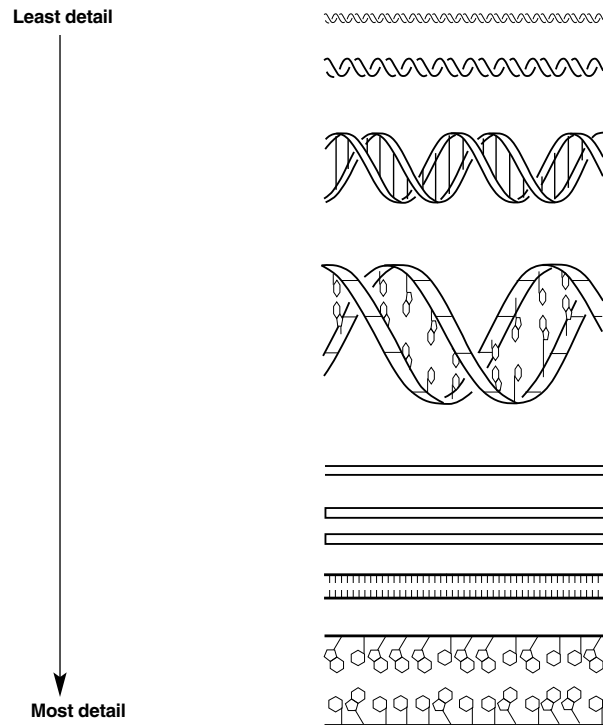

Fig. 15. DNA (deoxyribonucleic acid) — A long chainlike molecule that stores genetic information. DNA is graphically represented in a number of different ways, depending on the amount of detail desired.

DNA Replication — Strand Synthesis

New strands are synthesized by enzymes called **DNA polymerases**. New strands are always synthesized in the 5' to 3' direction. For a new strand of DNA to be synthesized, another single strand is necessary. The single strand of DNA that will be used to synthesize its complementary strand is called the **template strand**.

In order for DNA polymerase to start synthesizing a new complementary strand, a short stretch of nucleotides (approximately 20 base pairs long) called a primer (sometimes also called an oligonucleotide, for "few nucleotides") must be present for the polymerase to start the reaction. This primer is complementary to the template where synthesis will begin. The primer must have a free 3' hydroxyl group (OH) for DNA polymerase to attach the 5' phosphate group of the next nucleotide.

The DNA polymerase grabs free (single) nucleotides from the surrounding environment and joins the 5' phosphate of the new nucleotide to the 3' hydroxyl group (OH) of the new complementary strand. This 5' to 3' joining process creates the backbone of the new DNA strand.

The newly synthesized strand maintains its complementarity with the template strand because the DNA polymerase only joins two nucleotides during new strand synthesis if the new nucleotide has its complement on the template strand. For example, the DNA polymerase will only join a G to the 3' end of the newly synthesized strand if there is the C counterpart on the template strand. Guanine will not be joined to the new strand if A, T, or G is the opposite nucleotide on the template strand.

DNA polymerase and strand synthesis allow DNA to replicate during mitosis. Both new DNA strands are synthesized simultaneously from the two original DNA template strands during mitotic DNA replication.

DNA, RNA, and proteins are closely tied to each other. DNA directs the expression of RNA, which directs the expression of proteins, which carry out most of the biological functions that make up an organism. Thus, you can begin to understand why researchers, in an attempt to understand the mechanisms behind the various life processes, must study nucleotides to get complete answers about the flow of information carried in the genetic code. In the last 20 years, many gains in the areas of nucleic acid techniques have finally allowed researchers the means to study the roles of nucleic acids in life processes.

Individual discoveries by many scientists have contributed the pieces that have begun to solve one of the most mysterious puzzles of life — understanding the hereditary code. In 1985, enough pieces of the puzzle were in place for a major breakthrough to occur. This understanding of how the necessary molecular components interact to faithfully replicate DNA within living cells led to the development of a technique for creating DNA in a test tube. This technique is called the **polymerase chain reaction**, or **PCR**.

PCR: A closer look

PCR Makes Use of Two Basic Processes in Molecular Genetics

- 1. Complementary DNA strand hybridization**
- 2. DNA strand synthesis via DNA polymerase**

In PCR, complementary strand hybridization takes place when two different **primers** anneal to each of their respective complementary base pair sequences on the template. The two primers are designed and synthesized in the laboratory with a specific sequence of nucleotides such that they can anneal at the opposite ends and on the opposite strands of the stretch of double-stranded DNA (template strand) to be amplified.

Before a region of DNA can be amplified, one must identify and determine the sequence of a piece of DNA upstream and downstream of the region of interest. These areas are then used to determine the sequence of oligonucleotide primers that will be synthesized and used as starting points for DNA replication. Primers are complementary to the up- and downstream regions of the sequence to be amplified, so they stick, or anneal, to those regions. Primers are needed because DNA polymerases can only add nucleotides to the end of a preexisting chain.

The DNA polymerase used in PCR must be a thermally stable polymerase because the polymerase chain reaction cycles between temperatures of 52°C and 94°C. The thermostable DNA polymerase used in PCR was isolated from a thermophilic bacterium, *Thermus aquaticus* (*Taq*), which lives in high-temperature steam vents such as those found in Yellowstone National Park.

Two new template strands are created from the original double-stranded template on each complete cycle of the strand synthesis reaction. This causes exponential growth of the number of template molecules, i.e., the number of DNA strands doubles at each cycle. Therefore, after 35 cycles there will be 3.4×10^{10} , or over 30 billion, times more copies than at the beginning. Once the template has been sufficiently amplified, it can be visualized. This allows researchers to determine the presence or absence of the desired PCR products and determine the similarities and differences between the DNA of individuals. Depending on the DNA sequence analyzed, differences among individuals can be as great as hundreds of base pairs or as small as a single base pair or single point mutation.

PCR Step by Step

PCR involves a repetitive series of cycles, each of which consists of template denaturation, primer annealing, and extension of the annealed primer by *Taq* DNA polymerase. Before beginning DNA amplification, template DNA is prepared from evidence.

Following sample preparation, the template DNA, oligonucleotide primers, thermostable DNA polymerase (*Taq*), the four deoxynucleotides (A, T, G, C), and reaction buffer are mixed in a single micro test tube. The tube is placed into the thermal cycler. Thermal cyclers contain an aluminum block that holds the samples and can be rapidly heated and cooled across extreme temperature differences. The rapid heating and cooling of this thermal block is called **temperature cycling** or **thermal cycling**.

The first step of the PCR temperature cycling procedure involves heating the sample to 94°C. At this high temperature, the template strands separate (denature). This is called the **denaturation step**.

The thermal cycler then rapidly cools to 52°C to allow the primers to anneal to the separated template strands. This is called the annealing step. The two original template strands may reanneal to each other or compete with the primers for the primers' complementary binding sites. However, the primers are added in excess such that the primers actually out-compete the original DNA strands for the primers' complementary binding sites.

Lastly, the thermal cycler heats the sample to 72°C for *Taq* DNA polymerase to extend the primers and make complete copies of each template DNA strand. This is called the extension step. *Taq* polymerase works most efficiently at this temperature. Two new copies of each complementary strand are created. There are now two sets of double-stranded DNA (dsDNA). These two sets of dsDNA can now be used as templates for another cycle and subsequent strand synthesis.

At this stage, a complete temperature cycle (thermal cycle) has been completed (Figure 16).

Temperature cycle = denaturation step + annealing step + extension step

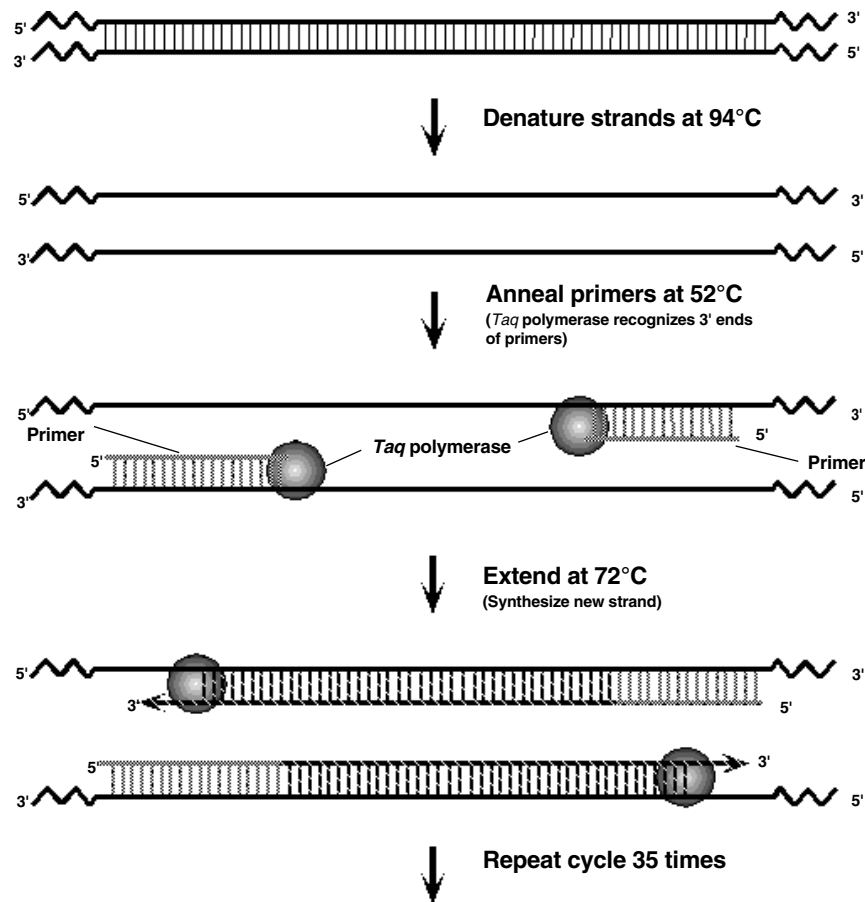

Fig. 16. A complete cycle of PCR.

Usually, thermal cycling continues for about 35 cycles. After each thermal cycle, the number of template strands doubles, resulting in an exponential increase in the number of template DNA strands. After 35 cycles there will be 3.4×10^{10} more copies of the original number of template DNA molecules.

PCR generates DNA of a precise length and sequence. On the first cycle, the two primers anneal to the original genomic template DNA strands at opposite ends and on opposite strands. After the first complete temperature cycle, two new strands are generated that are shorter than the original template strands but still longer than the length of the DNA that the researcher wants to amplify. It isn't until the third thermal cycle that fragments of the precise length are generated (Figure 17).

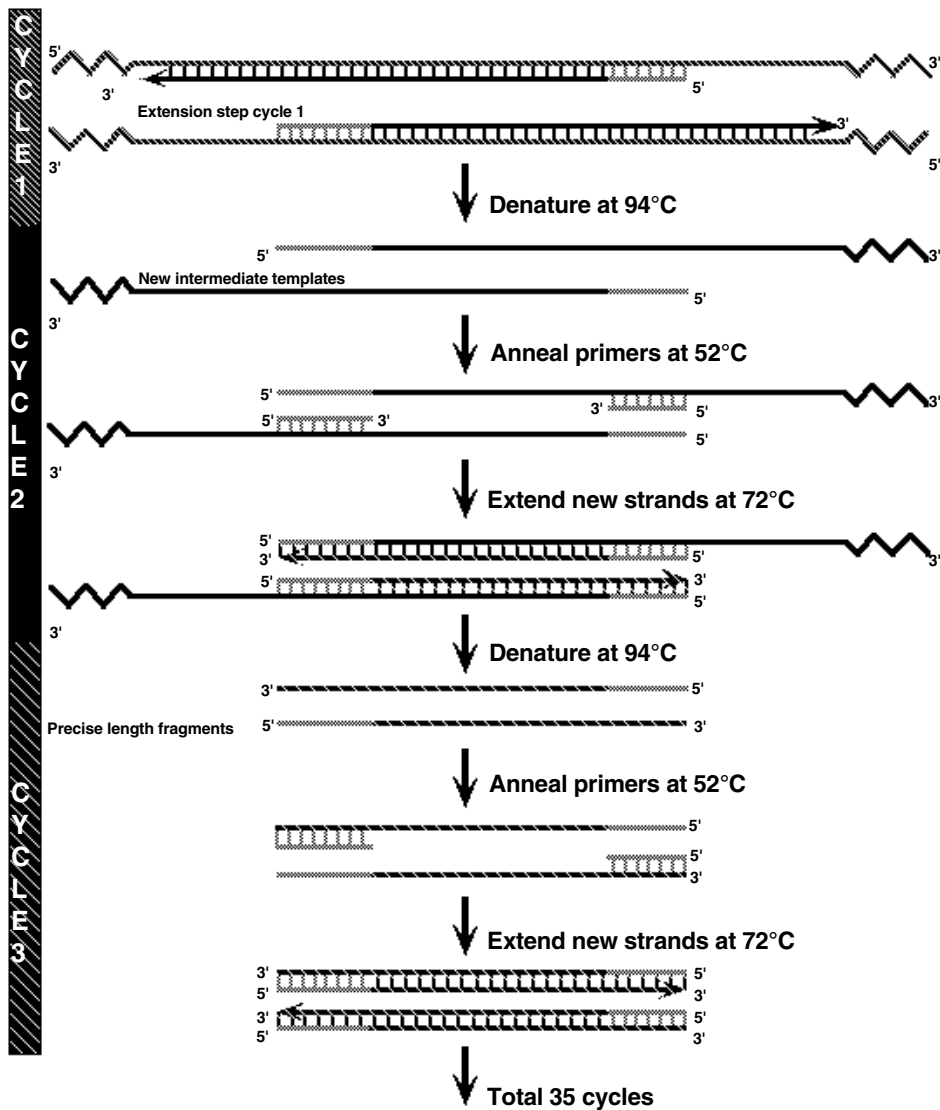

Fig. 17. Generation of precise-length fragments.

It is the template strands of the precise length that are amplified exponentially (X^n , where X = the number of original template strands and n = the number of cycles). There is always one set of original long-template DNA molecules that are never fully duplicated. After each thermal cycle, two intermediate-length strands are produced, but because they can only be generated from the original template strands, the intermediate strands are not exponentially amplified. It is the precise-length strands generated from the intermediate strands that are amplified exponentially at each cycle. Therefore, if 20 thermal cycles were conducted from one double-stranded DNA molecule, there would be 1 set of original genomic template DNA strands, 20 sets of intermediate template strands, and 1,048,576 sets of precise-length template strands (Figure 18). After 35 cycles, there would be 1 set of original genomic template DNA strands, 35 sets of intermediate template strands, and 3.4×10^{10} sets of precise-length template strands.

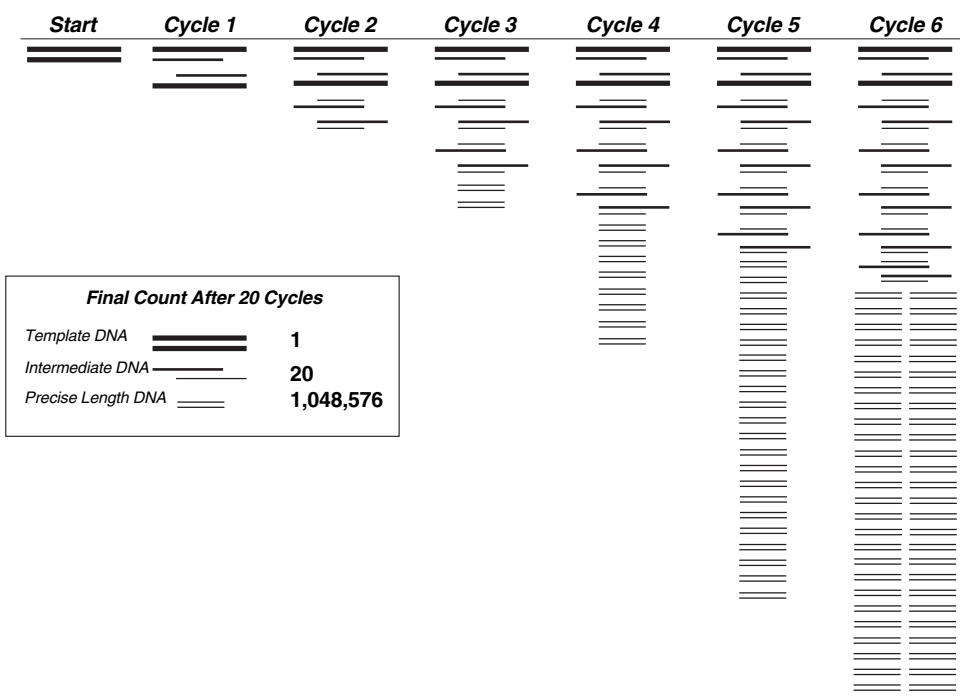

Fig. 18. Schematic of PCR amplification of DNA fragments.

Appendix B

A Brief History of Forensic Testing

Testing Speed vs. Power of Discrimination

Long before DNA evidence took center stage as the preferred means for identifying individuals, forensic laboratories still had the task of unambiguously linking suspects to crime scenes. They often did this indirectly, for example showing that the muddy shoe found in the suspect's car had a shoe print identical to that left at the scene of a crime. Or, showing that a plastic bag found in the suspect's house matched those found in the victim's house. On their own, these pieces of evidence are only suggestive – they don't actually prove that the suspect was at the scene of a crime. Something from the suspect must be left to be able to directly link that individual to the scene. Biological evidence is the key.

Blood typing

The first genetic tests were based not on DNA at all, but on blood types. There are 4 blood groups, or types – A, B, AB, and O. The test for blood groups is very fast and straight-forward. However, 40% of the population is type O, so it's not particularly useful if it turns out that several of your suspects are type O. Blood group determination is more useful to exclude potential suspects. If you know that someone left O-type blood at the scene of the crime, and the victim isn't type O, then you can exclude any suspects that have A, B, or AB blood.

RFLP

Restriction Fragment Length Polymorphism, or RFLP, has been the workhorse of forensic DNA profiling for many years. First described by English geneticist Alec Jeffries in 1985, RFLP makes use of the fact that certain regions in our genomes have DNA sequences that are repeated over and over again (called Variable Number of Tandem Repeats, or VNTRs) next to each other. Jeffries found that the number of repeats at any particular location differs from person to person. Using restriction enzymes that digest highly specific patterns in DNA, Jeffries was able to cut out the VNTRs and compare their sizes directly. He found that the locus (or allele marker) where repeats are found carried a pattern of repeats that comes either from the mother, or the father. In fact, the first legal application of RFLP was used to solve a British immigration case involving family relationships.

Although RFLP is a very powerful tool and has great discriminating potential, it is laborious, cannot easily be automated, and is time-consuming. As it depends on DNA sequences of relatively great size (a minimum of several hundreds of base pairs), DNA must be of at least reasonable quality, and not degraded. Older DNA samples may not be suitable. Perhaps its greatest drawback is that it often requires large amounts of DNA (tens of micrograms). This makes it unsuitable for many crime scenes where there may be only a single hair implicating a suspect.

STR

Short tandem repeats (STRs) are similar to VNTRs, since they too describe regions of DNA where you see DNA sequences repeated over and over. In this case, the repeat sizes are smaller – sometimes only 2 nucleotides are repeated. Like VNTRs, everyone inherits their STR pattern from their parents – for each locus, one STR allele comes from their mother, and one from their father.

STRs are much easier to analyze than RFLPs. First, because they are small they are easy to amplify using PCR. Second, because they can be amplified by PCR, STR tests can be automated, with several tests (>10) usually being run at the same time. Each PCR test

runs about 4 hours, compared to several days for RFLP. Third, even degraded DNA can generally give meaningful results. Degraded DNA may be broken into small fragments, which in most cases is acceptable for PCR, but not for RFLP. And finally, even a single piece of hair can yield enough genetic material to result in successful genetic analysis. While all these attributes are compelling, what makes STR analysis so powerful is that several loci containing STRs can be analyzed at the same time. Individual tests can, at best, distinguish 1 out of every 2000 or so people. In combination, as few as 13 loci can discriminate between any two people in the world (with the exception of identical twins), living or dead.

Of interest is the fact that STRs exist in all species tested to date. This has caused many groups to use STR analysis to trace bloodlines in certain species (such as dogs and race horses) where lineage tracking is big business.

DNA Profiling: What's next?

Several new areas are under development. Mitochondrial DNA (mtDNA) is one hot spot. mtDNA is unusual – it's non-nuclear, and so doesn't follow the same rules of inheritance as chromosomal DNA. In fact, it is generally accepted that mtDNA is maternally inherited. Of relevance to DNA profiling is the fact that mtDNA is a double-stranded circle. It contains many of the genes involved in the Krebs cycle (respiration). These genes function mainly inside mitochondria. Perhaps because it is circular, mitochondrial DNA tends to be much more stable than chromosomal DNA. Forensic analysts often refer to it as the "last resort", but may often check its quality first, before doing any other analyses; if mtDNA is degraded, then it's very likely that the chromosomal DNA is as well.

The reason that mtDNA is so useful for forensic purposes is its high copy number. Whereas a nuclear gene will have only two copies per cell (one from each parent), there are hundreds of copies of cytoplasmic mtDNA per cell, providing a much better opportunity for molecular analysis, even when material is limited.

It had been assumed that because the genes for mtDNA are so essential for metabolism, there would be little variation among people. However, recent efforts to compare mitochondrial DNA sequences in different human populations has shown that there is a 'hypervariable' region on mtDNA that differs significantly between individuals. These regions that have been validated for use in several crime labs, and there are a number of companies that specialize in mtDNA analysis for forensic cases. mtDNA has been especially useful in the identification of remains of missing persons, especially from mass graves and other disaster sites. In the 2004 Indian Ocean tsunami disaster, identification of victims involved a combination of STR analyses and mtDNA analyses.

Amplified fragment length polymorphism (AFLP) is a PCR-based variation of RFLP in which sequences are selectively amplified using primers. It is a reliable and efficient method of detecting molecular markers. DNA is cut with restriction enzymes to generate specific sequences, which are then amplified using PCR. AFLP can evaluate more loci than with RFLP. AFLP is also capable of determining a large number of polymorphisms. AFLP-based assays are cost-effective and can be automated.

Finally, there is much excitement over the potential for new forensic analysis using genomic sequences or patterns called single nucleotide polymorphisms, or SNPs. Single nucleotide polymorphisms are essentially single base pair polymorphisms that exist in all DNA. Several classes of SNPs exist. The one of most interest to forensic analysts are SSNPs, or silent single nucleotide polymorphisms, that don't actually change the outcome of any gene product or gene regulation. SNPs are good markers for a number of reasons – there are many more of them (one estimate suggests > 10 million) compared to other types

of markers, they are randomly distributed across the genome, they are bi-allelic (as compared to STRs, which have multiple possible states), and their distribution is fairly uniform. Presently, there are several drawbacks to using SNPs in forensic analysis. First, much more DNA is needed to perform SNP analysis than other methods currently in use in forensic case work. Another disadvantage of SNP typing for forensic applications is that a much larger number of the biallelic SNPs will need to be typed to achieve the same power of discrimination as the 13 multiple allelic STR loci. At this point in time, the cost of SNP typing is substantially higher than STR typing; this, plus the fact that crime labs are fully operational and validated for STR typing means that SNP typing is unlikely to be used for routine casework for some time.

In forensic DNA analysis, there is always a balance between speed, cost effectiveness, and the power of discrimination (Figure 19). STR analysis is the current method of choice as it is highly discriminating, and can be performed in a matter of hours. The other methods are either lacking in their ability to discriminate between two DNA profiles, or are too laborious or lengthy. That is not to say that they aren't used in forensic analysis. In addition, with improvements in technology and increasing information about the genome and mitochondria, it's likely that other methods may become favored over STR profiling.

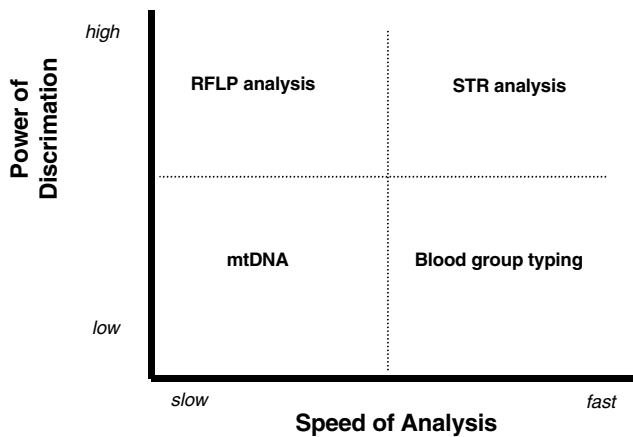

Fig. 19. Comparisons of forensic tests by speed and discrimination power.

DNA Sample Collection and the OJ Simpson case

As illustrated in the figure below, once crime scene samples have been collected, they are taken back to the lab so that DNA may be extracted, quantitated, and analyzed. PCR is then performed to make copies of the specific region or regions that are under analysis. In the CODIS system (**CO**mbined **DNA** Index **S**ystem; for more information, see information about the CODIS database in this Appendix), PCR primers have been designed to amplify 13 different regions of the human genome. Each set of primers amplifies only one region. Each separate region, or loci, contains an STR that numbers anywhere from 8 to 32 repeats, depending on the loci. To be able to maximally analyze the greatest number of samples in one reaction, the companies that developed these tests did two things – first, they labeled the primers used for PCR with different fluorescent tags. Second, they made the primers in such a way that the PCR products could be distinguished not only by fluorescent color but also by size. In other words, no two over-lapping PCR products would have the same color.

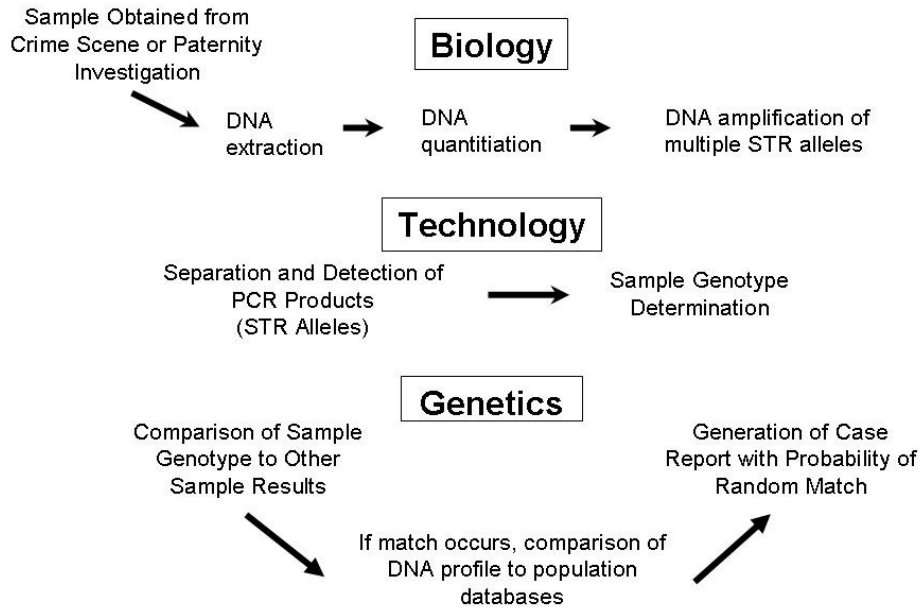

Fig. 20. Steps in forensic DNA sample processing (7).

After completing the PCR reaction, PCR products are separated by size on acrylamide gels and the fluorescent products detected. A typical forensic DNA profiling gel is shown in figure 21 for 7 tested loci. Since the PCR products to be detected are very small (e.g. <50 bp), the better resolving power of acrylamide is necessary for optimum resolution. Once the fluorescent products have been detected, a program automatically compares the products to allele ladders (size markers), and identifies each product based on its size and color match to these allele ladders. The program then assigns a genotype, or DNA profile, for each individual sample for each locus tested.



Fig. 21. A typical STR gel. Four different fluorescent tags have been used to identify 7 amplified loci. Allele ladders, or markers, are indicated by arrows.

This DNA profile is then compared to other samples. In forensic studies, this might mean that a sample from a crime scene is compared to that of many suspects. If the samples don't match, then those suspects can be excluded from the crime scene. If there is a match, then those suspects are included in the investigation. At this point, the included DNA profiles may then be compared to a database (such as can be found on STRbase www.strbase.org) to understand whether the genotypes are more prevalent in particular ethnic groups to give a better estimate of the random match probability. In general terms, the random match probability tells you the likelihood of whether someone else from that particular population will have exactly the same genotype. To read more about this topic, see Appendix C.

As DNA testing technologies continue to improve and become able to analyze ever smaller amounts of starting material, it will become even more important that samples are collected appropriately. If you happened to sneeze while collecting evidence from a crime scene, you could find yourself the chief suspect in a murder investigation. Suspect collection and sample processing are the most vulnerable part of any investigation, because that is the point that evidence is most prone to contamination. Contamination means that a sample is impure. It's worth noting that crime scenes often produce mixed samples. Imagining the motel room scenario, many people may have stayed in the room before the crime was committed, and certainly left DNA evidence behind. For DNA evidence, contamination means that more than one DNA type may be present in the same sample (possible, depending on the crime), or that the DNA has been exposed to a substance that interferes with analysis. Either situation can have a big outcome on analysis. Inconclusive DNA evidence can have as big an effect in the courtroom as conclusive evidence. Because of this, police take special precautions when collecting evidence for DNA profiling:

1. Always wear gloves. Skin is an excellent source of cells containing DNA, and everyone sheds skin cells constantly. Only a few cells are needed as the basis for DNA profiling. Gloves can help prevent contamination of suspect collection.
2. Tie hair back or cover it. As we've already mentioned, a single hair is all it takes to implicate someone at a particular place.
3. Sneezing or coughing can expel cells all over evidence, so a mask is often worn.
4. Crime scenes, and evidentiary samples, must be treated in such a way that biological materials are not accidentally transferred from one place to another, thereby providing misleading associations. In one famous crime scene, the body of the victim was covered with a blanket from the household – this mistake made any hairs found on the victim of no value since it wasn't possible to determine whether they were evidence of contact with the person who committed the crime, or were simply transferred to the victim by accident.

As an example of how these procedures can affect the outcome of a criminal investigation, let's take a look at the OJ Simpson trial:

In 1995, Nicole Brown Simpson and a friend, Ron Goldman, were found murdered at the home of Ms. Simpson. Nicole's ex-husband, OJ Simpson, became the primary suspect. A substantial amount of evidence linked Mr. Simpson to the scene of the crime, and DNA profiling (both RFLP- and STR-based) was used to create DNA profiles of the many bloodstains found at the homes of Ms. Simpson and Mr. Simpson. Of 45 bloodstains discussed at trial, all were identified as coming either from the two victims, or from Mr. Simpson (9). However, despite the weight of evidence, Mr. Simpson was acquitted. A prominent criminologist, Dr. Henry Lee, planted doubt in the jury's mind by suggesting that crime scene samples had been mishandled. In addition, this was one of the first, and most prominent, cases involving DNA evidence, so the prosecution devoted a lot of court time to

the complex procedures involved in DNA profiling. The defense was able to plant sufficient doubt in the minds of the jurors that the initial sample collection was either sloppy, or that someone intentionally mishandled evidence. Much of the defense's effort was focused on a police officer that they claimed was so biased that he deliberately planted evidence implicating the defendant. The possibility that a police officer could have mishandled evidence was enough for the jury to acquit.

Despite this apparent setback to DNA profiling, it continues to be used in countless court cases. In 1983, Calvin Johnson was accused and convicted of rape and burglary. Today, he is free because DNA evidence showed he was not the man who committed the crime. DNA profiling has been used outside of the courtroom to settle parental issues, and to identify individuals involved in many disasters. The table below mentions some of the milestones and achievements in forensic analysis.

Milestones in forensic DNA analysis

Year	Event
1985	Alec Jeffries develops multi-locus RFLP probes
1988	FBI starts work using single locus RFLP
1990	PCR analysis using single locus STR begins
1992	FBI initiates STR work using DQA1 locus
1994	DNA Identification Act: provides funding for national DNA database
1995	OJ Simpson trial focuses public attention on DNA evidence
1996	FBI starts to test mtDNA; first multiplex STR kits available
1997	13 core STR loci described
1998	FBI starts CODIS database; Swissair disaster – all remains identified using STR DNA profiling
2001	World Trade Center disaster in NYC – many remains identified using a combination of DNA profiling approaches (8)
2004	California proposition 69: State DNA Database Funding Initiative. State initiative passed with 62% of vote. (14)
2004	Indian Ocean tsunami; Interpol and other world agencies to use DNA profiling to identify victims
Today	Trace your Genetic Genealogy; commercially available packages can trace paternal/maternal ancestry

The CODIS system and DNA Databases

The collection and stockpiling of DNA evidence has the potential to be of great help to law enforcement. CODIS, or Combined DNA Index System, is a federally maintained database of DNA obtained from crime scenes and convicted violent offenders. CODIS works on federal, state, and local levels to obtain and maintain DNA profiles (13). All DNA profiles originate at the local level, and then migrate to the state and federal levels.

Although CODIS is administered at the federal level, states have the power to legislate local DNA evidence collection. Although CODIS was originally designed to collect information about violent criminals, many states have now enacted legislation that allows collection of DNA evidence even if that person is not convicted of a crime.

In California, proposition 69 requires the collection of DNA from anyone convicted of any felony offense, or any violent sexual assault (14). It also requires DNA collection from anyone arrested or charged with various violent crimes or felony offenses. In favor of this, proponents say that too many violent crimes go unsolved because California does not have a comprehensive DNA database. Further, they point out that the tests do not reveal any medical conditions about individuals, so medical privacy would not be violated.

However, opponents object to DNA collection from people who have not been convicted of a crime. Further, they feel that privacy safeguards are not adequate, and that the state is not compelled to respond to requests to have innocent individuals' information removed. Many people also feel that even one corrupt official could compromise the privacy rights of countless individuals. This is a controversial area, and is continually being examined and developed.

How does CODIS actually work?

CODIS examines 13 loci, or markers, that are uniformly distributed across the human genome. The loci used, and their relative positions, are listed below in Figure 22.

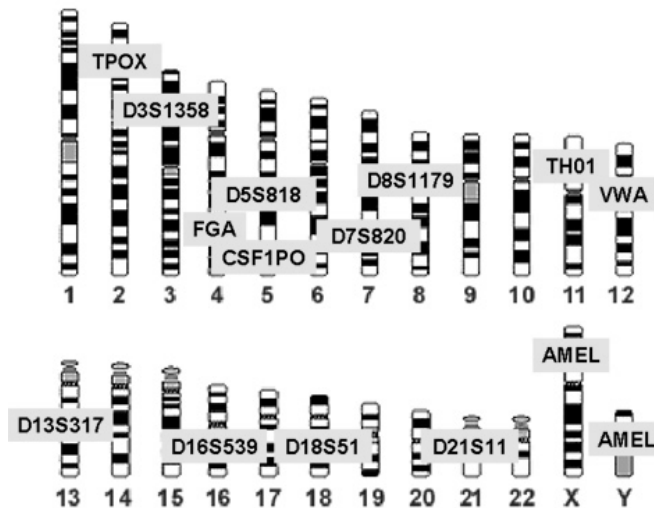

Fig. 22. The 13 core CODIS loci and their genetic locations (7).

In addition to the 13 loci used for STR profiling, forensic analysts also analyze the amelogenin locus. PCR products at this locus produce X chromosome and Y chromosome specific PCR products of different sizes. The amelogenin locus therefore provides gender information about a particular DNA sample.

One important feature of these 13 loci is that they have been carefully chosen so that they reveal no medical or health information about the individual being profiled. That is, these loci come from regions of the human genome that are not known to be associated with any disease or condition. For that reason, they are called "anonymous" markers.

Why choose 13 loci?

The ability to distinguish between any two individual DNA profiles increases with the number of loci tested. If only one locus was examined, many people would likely have the same genotype, and so telling the difference between any two people would be very difficult. In addition, allele frequencies have been shown to vary between ethnic groups. Depending on the ethnic group under study, the power of discrimination at any one locus may only be 1 out of every 200 people. With the addition of more loci, the ability to discriminate between two profiles increases. Take a look at the following fictitious DNA profile. The alleles identified in this person's STR DNA profile and the frequencies in Caucasians for those alleles (3) are listed. The final row lists the Random Match Probability (RMP; described in more detail in Appendix C) for the combined genotype. The RMP tells you how likely it is for anyone else to have the same genotype. For this particular genotype, there is about a one in 2.7 trillion chance that another Caucasian has the same genotype. Since there are only ~ 6.5 billion people alive on Earth today, that's a highly discriminating number!

Fictitious DNA Profile: Random Match Probability Calculation				
STR locus	Identified allele	Allele frequency in Caucasians (from database)	Locus frequency in Caucasians	
			Formula	Locus frequency
TPOX	8 12	$p = 0.535$ $q = 0.041$	$2pq$	0.044
TH01	10 10	$p = 0.008$	p^2	0.000064
D3S1358	16 17	$p = 0.253$ $q = 0.215$	$2pq$	0.109
FGA	21 23	$p = 0.127$ $q = 0.134$	$2pq$	0.034
CSF1PO	11 13	$p = 0.301$ $q = 0.096$	$2pq$	0.058
D8S51	14 19	$p = 0.137$ $q = 0.038$	$2pq$	0.010
D21S11	28 29	$p = 0.159$ $q = 0.195$	$2pq$	0.062
			Combined genotype frequency	
Total RMP for this genotype = frequency of TPOX locus [f (TPOX)] x frequency of TH01 locus [f (TH01)] x frequency of D3S1358 locus [f (D3S1358)] etc.			f (TPOX) x f (TH01) x f (D3S1358), etc.	3.75×10^{-13} or ~1 in 2.7 trillion

Fig. 23. Fictitious DNA Profile – Random Match Probabilities. In this imaginary Caucasian DNA profile, 7 loci have been examined. One locus – TH01 – is homozygous, so only one allele has been identified. A locus frequency is indicated for each combination of alleles at a particular locus, and the total RMP for the combined genotype is also shown.

To calculate the genotype frequency at any particular locus, you need to take into account the possibility of inheriting the combination of alleles present at that particular locus from each parent. Allele frequencies have been shown to vary between different ethnic groups, and these frequencies have been published (3). As an example, let's look at the TPOX locus. In Caucasians, the frequency of the 8 allele (let's call this frequency ' p ') is $p = 0.535$. This means there's about a 53.5% chance that any Caucasian TPOX allele typed would be an 8. Similarly, there's a $q = 0.041$ chance that a random TPOX allele would be typed as a 12. The chance that this person got the 8 allele from his mother and the 12 allele from his father is represented as pq , and the opposite – that he got the 8 from his father and the 12 from his mother – is also pq , so the locus frequency at any heterozygous locus can be thought of as $pq + pq$ or $2pq$. So, $2 \times (0.535)(0.041) = 0.044$, or 4.4%, of Caucasians have the 8, 12 genotype at the TPOX locus.

At the TH01 locus, since both alleles are the same, the frequency is simply pp , or p^2 , which is the combined chance of inheriting allele 10 from each parent. So, about 0.0064% of Caucasians have this particular genotype at the TH01 locus.

The Hardy-Weinberg theory is the principle behind the formulae for calculating genotype frequencies at any locus (i.e. p^2 , $2pq$). In essence, Hardy-Weinberg describes the probable genotype frequencies in a population and tracks their changes from one generation to another. In the case of STR calculations, it allows geneticists to take observed allele frequencies and calculate a genotype frequency as described above in the table.

In our example in the table above, the chance for any Caucasian to have this particular combined genotype (TPOX 8, 12; TH01 10,10) is 0.044×0.000064 which is $\sim 3 \times 10^{-6}$ or ~ 3 in 100,000 of all Caucasians screened at these two loci (TPOX and TH01). Mendel's Law of Independent Assortment tells us that alleles are inherited independently, so the Product Rule can be applied to make this calculation. The Product Rule says the combined genotype frequency is the product of all of the separate loci frequencies (represented generically as ' f '; see the table under combined genotype frequency), as described above for the TH01 and TPOX alleles. The genotype frequency may also be described as the Random Match Probability, or RMP. RMP is described in more detail in Appendix C.

In the US, 13 loci are used for analysis. The combined RMP using 13 loci provides enough discrimination power to tell the difference between any 2 people in the world, with the exception of identical twins. In the UK, law enforcement has elected to use only 10 loci, which could, in some cases, lead to a situation where more than one person has the same identified genotype.

Plant and Insect Genotyping in Forensic Investigations

The vast majority of DNA profiling associated with criminal investigations involves profiling of the people implicated in the crime. However, genetic profiling using many of the methods described is also performed in some instances, where the particular genotype of a plant or an insect can help associate a piece of evidence with a known location or time. For example, smuggling of endangered species of plants and animals is still prevalent in many parts of the world. To be able to identify animals and plants specifically, many of the same tests described in this Appendix are employed.

Forensic entomology, or the application of the study of insects to criminal cases, is the field devoted to these studies in homicide and wildlife poaching investigations. Insects colonize remains shortly after death and develop in a predictable way. Identification of insects using the methods described here as well as other methods allow an entomologist to estimate elapsed time since death, as well as other factors such as position of wound sites, and whether the body has been moved or disturbed.

Appendix C

Exercises in STR Allele Frequencies and Random Match Probabilities

Exercise 1: Simulation of Inheritance of STR Allele and Power of Discrimination

The Crime Scene Investigator PCR Basics kit allows students to simulate a genotyping at one of the loci commonly used in forensic typing. In real crime scene applications, DNA profiling is performed at a number of different loci to improve the power of discrimination of the testing. In simple terms, the power of discrimination is the ability of the profiling to discriminate between different individuals. The larger the number of loci profiled, the more powerful the ability to discriminate.

This concept can be illustrated in the classroom with a very simple exercise. All students are asked to stand, and they now form a pool of possible suspects for a hypothetical crime. There is an eyewitness who saw the criminal run from the crime scene and has provided a description. As will be apparent, the more bits of identifying information provided by the witness, the greater the number of persons excluded from the suspect pool, and the smaller number of suspects included in the suspect pool. The teacher provides bits of identifying information, asking those who are no longer suspects to sit. The teacher repeats this process (selecting from the suggested list below, but in an order that continues to eliminate students from the pool of suspects) until only one student remains standing – there is now a suspect pool of one! Some of the types of information provided by an eyewitness might include the following:

The criminal wore blue denim jeans.

The criminal wore a T-shirt (or sweatshirt, depending on the season) with letters on it.

The criminal wore glasses.

The criminal had ____ hair color.

The criminal had very short or long hair.

The criminal was male or female.

The question to ask the students is: Does this prove that [name] committed the crime? Why or why not?

The correct answer is that the last student standing could have committed the crime, but an important consideration is whether any other persons who fit this same description were also present. In other words, what is the possibility that another person has this exact set of features? This same consideration comes into play with DNA profiling. What is the chance that a randomly selected individual will have the same identical DNA type of the suspect? This random match probability is an important component of using DNA evidence to solve crimes.

Adding more pieces of observation to the physical description of the escaping criminal made it more likely to identify the correct person as guilty (or innocent). In exactly the same way, adding more genetic loci to the DNA profiling profile makes it a much more powerful tool for solving crimes.

In the US, 13 STR loci have been chosen for forensic typing and inclusion in the national database called CODIS. The average random match probability when all 13 are typed is less than one in a trillion. Since the total world population is about 6.5 billion people, that means that the CODIS system can in theory tell the difference between any two people, with the exception of identical twins.

The next part of the exercise demonstrates the inheritance of STR alleles at four loci and shows how even siblings will have different profiles. The four STR loci we will model are actually used in forensic typing:

Locus name	Chromosome	Allele Range (# repeats)
VWA (blue)	12	10–24
D8 (green)	8	8–19
D5 (yellow)	5	7–16
TH01 (red)	11	3–14

Materials required for each class:

- 8 small paper bags
- Blocks or small squares of poster board in red, blue, green, yellow (total number = 2 of each color per student)
- Student worksheets, transparency or board copy of the table

Before class, the teacher will

- Label $\frac{1}{4}$ of each of the blue blocks with one allele (13) for VWA, $\frac{1}{4}$ with a second different allele (18), $\frac{1}{4}$ with a third, different allele (16), and $\frac{1}{4}$ with a fourth, different allele (20) with a permanent marker. Keep the piles of labeled blocks separate. Place two sets of alleles in one paper bag labeled "mom, VWA"; put the remaining two sets into another paper bag labeled "Dad, VWA"
- Repeat with green blocks using D8 alleles (8, 12, 9, 13). Place two sets in a bag labeled "mom, D8" and two sets in a bag labeled "Dad, D8"
- Repeat with yellow blocks using D5 alleles (7, 11, 10, 12). Place two sets in a bag labeled "mom, D5" and two sets in a bag labeled "Dad, D5"
- Repeat with red blocks using TH01 alleles (7, 11, 10, 12). Place two sets in a bag labeled "mom, TH01" and two sets in a bag labeled "Dad, TH01"

In class:

1. One student is named the "mom" of the family and one student the "dad". The mom will take the four bags marked "mom" and the dad will take the four bags marked "dad". They will determine their genotypes at each of the four STR loci; all students will enter these into their data sheets.
2. Each student now "inherits" his or her STR genotype by selecting at random one allele from each of the Mom's bags and one allele from each of the Dad's bags. Each student enters his or her data on the blackboard or transparency master sheet and all students transcribe the data onto their worksheets. By repeating for each student in class, a large "family" of children with the same mother and father have been generated.

Question 5: How do your results demonstrate the principle of increasing power of discrimination used in forensic DNA profiling?

Question 6: If more than one child shared the same genotype, what possible explanations are there?

Exercise 2: Random Match Probabilities

For PowerPoint presentation, lecture information, and figures for STR profiling, instructors are referred to: <http://www.cstl.nist.gov/biotech/strbase/>

Because each of the loci used in forensic DNA profiling is on a different chromosome, they are each inherited independently of each other (Mendel's Law of Independent Assortment of Chromosomes is the underlying genetic principle). This fact allows the forensic scientist to use the **product rule** to calculate the frequency of any given DNA profile by multiplying individual allele frequencies together. In other words, this is the probability that another person, chosen at random from a population, will have exactly the same genotype, and is also known as the **random match probability (RMP)**.

$RMP = f(VWA-1) \times f(VWA-2) \times f(D8-1) \times f(D8-2) \times f(D5-1) \times f(D5-2) \times f(TH01-1) \times f(TH01-2)$
Where f(...) is the frequency of that allele in the population.

Allele frequency is basically a measure of the relative abundance of a specific allele in a given population. Allele frequencies for the 13 CODIS STR loci are available in many public databases. For this portion of the exercise, visit STRBase on the internet (<http://www.cstl.nist.gov/biotech/strbase/>) and select "Data from NIST US Population Samples". Next click on "Allele Frequencies published in the Journal of Forensic Science" and open the article. Table 1 shows allele frequencies for a Caucasian population, table 2 for an African American population, and table 3 for a Hispanic population.

Use these tables to complete the following chart by writing the allele frequency for each of your alleles from each population:

	VWA alleles		D8 alleles		D5 alleles		TH01 alleles	
My genotype (from Exercise 1)								
Frequency:								
Caucasian								
African American								
Hispanic								

Question 1: What do you notice about allele frequencies among populations? Is there any specific trend?

Question 2: Forensic laboratory genotyping results often report RMPs for specific populations. Use the data in your chart to explain why this might be important. **Hint:** remember that the match probability is used to provide some indication about the "pool" of potential people with the same genotype as a suspect.

Question 3: Use the data from the chart to calculate an RMP for your own genotype for each of the populations. Insert the frequencies for your own alleles into the RMP formula and calculate.

Write the RMP formula with your alleles inserted:

Calculation based on Caucasian population:

Calculation based on African American population:

Calculation based on Hispanic population:

Discussion Questions

1. Imagine that blood, known to come from a criminal, was left at the scene of a crime, collected, and typed for the 13 CODIS loci. No suspect has been arrested, and there are no good investigative leads. Do you think that genotypes at the 13 CODIS loci should be used to make conclusions about the race of any potential suspect? Use what you have learned from the STRBase tables to support your position.
2. What are some of the difficulties in using population studies based on race?

Appendix D

PCR Amplification and Sterile Technique

PCR is a powerful and sensitive technique that allows researchers to make large amounts of DNA from very small amounts of starting material. Because of this sensitivity, contamination of PCR reactions with unwanted, extraneous DNA is always a possibility. Therefore, great care must be taken to prevent cross-contamination of samples. Steps to prevent contamination and failed experiments include:

1. **Filter-type pipet tips.** The end of the barrel of micropipets can easily become contaminated with aerosolized DNA molecules. Pipet (or aerosol barrier) tips that contain a filter can prevent aerosol contamination from micropipets. DNA molecules within the micropipet cannot pass through the filter and cannot contaminate PCR reactions. Xcluda™ aerosol barrier pipet tips (catalog #211-2006EDU and 211-2016EDU) are ideal pipet tips to use in PCR reactions.
2. **Aliquot reagents.** Sharing of reagents and multiple pipettings into the same reagent tube will likely introduce contaminants into your PCR reactions. When possible, aliquot reagents into small portions for each team, or for each student. If an aliquotted reagent tube does become contaminated, then only a minimal number of PCR reactions will become contaminated and fail.
3. **Change pipet tips.** Always change pipet tips. If a pipet tip is used repeatedly, contaminating DNA molecules on the outside of the tip will be passed into other solutions, resulting in contaminated PCR reactions. If you are unsure if your pipet tip is clean, discard the tip and get a new one. The price of a few extra tips is a lot smaller than the time, effort, and cost of failed reactions.
4. **Use good sterile technique.** When opening, aliquotting, or pipetting reagents, leave the tube open for as little time as possible. Tubes that are open and exposed to the air can easily become contaminated by DNA molecules that are aerosolized. Go into reagent tubes efficiently, and close them when you are finished pipetting. Also, try not to pick tubes up by the rim or cap as you can easily introduce contaminating DNA molecules from your fingertips.
5. **Sterilize your equipment and work area.** 10% bleach destroys DNA; wiping down surfaces and rinsing pipet barrels with 10% bleach can get rid of any DNA contamination that may arise.

Appendix E

Glossary of Terms

Allele – A version of a genetic marker, or locus.

Aliquot – The division of a quantity of material into smaller, parts.

Annealing – Binding of oligonucleotide primers to complementary sequences on the template DNA strands.

CODIS – **CO**mbined **DNA** **I**ndex **S**ystem is a federally maintained database of DNA obtained from crime scenes and convicted violent offenders.

Cofactors – Ions or small molecules needed by an enzyme to function properly. For example, *Taq* DNA polymerase needs Mg^{2+} in order to function properly. Mg^{2+} would therefore be considered a cofactor.

Denature – The process of melting apart two complementary DNA strands. In vivo denaturation is accomplished by enzymes; in PCR, denaturation is accomplished by heat.

dNTPs – Commonly used abbreviation for all four deoxynucleotide triphosphates (dATP, dTTP, dGTP, dCTP) used in synthesizing DNA.

Ethidium bromide – A fluorescent dye molecule that intercalates between DNA base pairs and fluoresces when exposed to ultraviolet light.

Eukaryotes – Organisms that are made up of cells containing a membrane-bound nucleus that contains the genetic material (DNA).

Exon – The region of a transcribed messenger RNA molecule that gets spliced together and leaves the nucleus for translation into protein sequence.

Extension – This refers to the process of *Taq* polymerase adding dNTPs (deoxynucleotide triphosphates — dATP, dTTP, dCTP, or dGTP) onto the ends of oligonucleotide primers. Extension follows the base pairing rule and proceeds in the 5' to 3' direction.

Genome – A person's complete nuclear genetic make-up. The blueprint to make exactly one particular person, tree, dog, or anything else that relies on DNA.

Genomic DNA – The sum total of the DNA that is found within the nucleus of a cell.

Genotype – The set of markers (alleles) present in a DNA sample.

Intron – The region of a transcribed messenger RNA that is spliced out of the mRNA and is not translated into protein sequence.

Locus – A genetic marker. A locus refers to a position on a chromosome, and may or may not be linked to a gene. (plural, loci)

Lysis – The process of rupturing a cell to release its components.

Master Mix – The main solution of a PCR reaction which contains all of the necessary components (dNTPs, primer, buffer, salts, polymerase, magnesium) of the reaction except the template DNA.

Nucleotides – The fundamental unit of DNA or RNA. They consist of a sugar (deoxyribose or ribose), phosphate, and nitrogenous base (adenine, thymine, cytosine, or guanine and uracil in place of thymine in RNA).

Oligonucleotide – A DNA or RNA molecule usually composed of a small number of nucleotides; see also primer.

PCR – Polymerase chain reaction. The process of amplifying or synthesizing DNA within a test tube.

Polymorphism – Literally translates as "many forms". Polymorphisms refer to genetic differences at a particular locus. A single locus may be polymorphic in different individuals, having several different alleles.

Power of Discrimination – The ability to discriminate between any two genotypes. The power of discrimination increases as more loci are analyzed.

Primers – A small series of nucleotides (usually 3-30 bases in length) that bind to a particular sequence of nucleotides on the target DNA sequence. Primers for PCR are usually synthesized in a laboratory. See also oligonucleotides.

Reagents – Materials needed to conduct an experiment. They are usually solutions or mixtures of various solutions.

Restriction Fragment Length Polymorphism (or RFLP) – A DNA test used to distinguish VNTRs. DNA is digested with enzymes, and particular sequences examined by use of a probe that binds to the DNA region of interest.

STR – Short Tandem Repeat, very small repeated DNA sequences. Repeats may be only 2 to 4 nucleotides in length. STRs are inherited, and vary from person to person, and from locus to locus. STRs are the basis for a commonly used PCR-based DNA test.

Taq DNA polymerase – Heat stable DNA polymerase that was isolated from the heat tolerant bacterium *Thermus aquaticus*. This DNA polymerase is commonly used in PCR reactions.

Template – The strand of DNA that contains the target sequences of the oligonucleotide primers and that will be copied into its complementary strand.

Variable Number of Tandem Repeats (or VNTRs) – DNA sequences that are made up of large, repeated elements. The repeated DNA elements may be many kilobases in length. VNTRs are inherited, and vary from person to person, and from locus to locus.

Appendix F

Programming Instructions for MyCycler™ Thermal Cycler

Abbreviated instructions for programming your MyCycler for the proper amplification cycles and temperatures used in this lab are provided below. Refer to the MyCycler instruction manual for more detailed instructions and troubleshooting.

MyCycler Thermal Cycler

Select "Standby" to turn the machine on

Select "Create"

Scroll down to "Standard-3"

Press "Enter"

Program the Initial Denaturation

Enter 94.0

Press the down arrow

Enter 2.00

Press the down arrow

Enter 1.00

Press the right arrow

Program the 35 PCR cycles

Enter 94.0

Press the down arrow

Enter 0.30

Press the right arrow

Press the up arrow

Enter 52.0

Press the down arrow

Enter 0.30

Press the right arrow

Press the up arrow

Enter 72.0

Press the down arrow

Enter 1.00

Press the down arrow

Enter 35X cycles

Press Enter

Program the Final Extension

Press the right arrow

Enter 72.0

Press the down arrow

Enter 10.00

Press the down arrow

Enter 1X cycle

Press the right arrow

Program the Final Chill Hold

Enter 1X cycle

Press "Done"

Save the Protocol

Press "Save Protocol As"

Press "Enter"
Enter 'Crime Scene PCR' using the alphanumeric keypad
Press "Enter"

Run the Crime Scene PCR Program

Select "Protocol Library"
Select "Crime Scene PCR"
Press "Enter"
Press "Enter" to run protocol
Enter "Algorithmic Measurement"
Enter 40 µl volume
Select "No Hot Start"
Select "Begin Run"
The MyCycler should now begin running

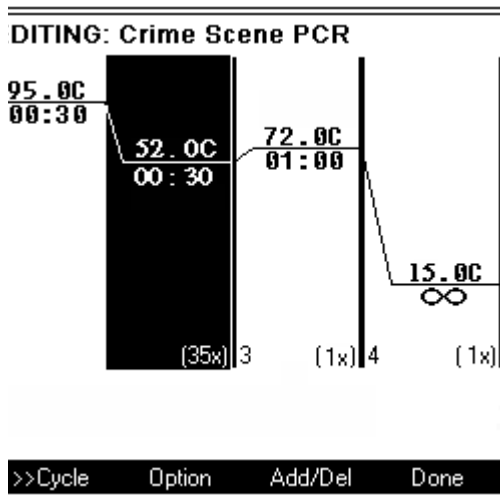

Appendix G

Teacher Answer Guide

Student Questions – Introduction

- 1. What kinds of materials obtained from a crime scene might contain DNA, and where might you find them at a crime scene?**

Any kind of biological material – blood saliva, skin, hair, or bone are examples. These can be found on drinking glasses (saliva), a hairbrush or toothbrush (hair and skin), bloodstains, etc.

- 2. Why do you need to perform PCR on DNA obtained from a crime scene?**

Probably nothing. The amount of DNA extracted from evidence is so small that in most cases it cannot be seen without some kind of manipulation (PCR amplification for example) first.

- 3. What might you see if you ran a DNA sample extracted from evidence on a gel before running PCR?**

Usually very small quantities of DNA can be extracted from evidence obtained at crime scenes. PCR is performed to make enough DNA for analysis.

- 4. What is a genotype?**

A genotype is a person's own genetic makeup. Usually, it's a snapshot of genetic information from different loci scattered across the genome.

- 5. What is the difference between an allele and a locus?**

A locus is a particular location on a chromosome. An allele is a particular variation of any individual locus.

- 6. Why do forensic labs analyse non-coding DNA and not genes?**

Non-coding DNA is used for forensic analyses because it does not carry any information about gene expression patterns. By general agreement within the forensic community, these sequences are preferred, because they only provide information about relatedness, and say nothing about a person's biological state (for example health, mental well-being, or physical state).

Lesson One: Setting up PCR Reactions

- 1. What does PCR allow you to do with DNA?**

PCR allows you to make enough copies of DNA to perform analysis.

- 2. What components do you need to perform PCR?**

A template, DNA polymerase enzyme, nucleotides (dNTPs), primers, and buffer (containing Tris, salt, etc.).

- 3. What is in the master mix and why do you need each component?**

- Taq polymerase – a polymerase that is not sensitive to heat. It "sews" together the deoxynucleotide triphosphates to make a new DNA strand that is complementary to the template.*
- Deoxynucleotide triphosphates ATCG – used to make the complementary strand.*

- *Primers – short sequences of DNA that are complementary to DNA one wishes to amplify. There are 2 types: forward and reverse. They are separated by the base pairs in the sequence of DNA being amplified. The size of the PCR product is equal to the size of the amplified region of DNA plus the number of base pairs in the primers.*
 - *Buffers and cofactors needed to make the reaction take place at an optimal rate.*
- 4. Why do you need to perform PCR on DNA evidence from a crime scene?**
- PCR is needed because there is usually not enough DNA obtained from a crime scene to analyze or visualize.*
- 5. What steps make up a PCR cycle, and what happens at each step?**
- Each PCR cycle is made up of 3 steps.*
- *Denaturation – the DNA strands are melted apart.*
 - *Annealing – primers bind to complementary sequences on the DNA.*
 - *Extension – DNA polymerase adds nucleotides to primers.*

Lesson Two: Electrophoresis of PCR products

1. Why does DNA move through an agarose gel?

Since DNA is negatively charged, it can be separated using an electric current. In fact, electrophoresis means "carry with current". Movement through the gel occurs when an electric current is applied across the gel. Since the gel is immersed in buffer, the current will travel through the buffer and gel, carrying the negatively charged DNA with it toward the positive anode.

2. What are the two techniques used to create a DNA profile? What function does each perform?

PCR and gel electrophoresis are used to create a DNA profile. PCR is used to amplify sufficient amounts of a DNA sample to be analyzed. Gel electrophoresis separates bands based on size. After the bands are separated the gel is stained to visualize the band pattern. By comparing the bands in the gel to a standard, we can estimate their size.

3. What is an allele ladder? What is its function in DNA profiling?

An allele ladder is a mixture of the alleles possible at a particular locus. The Allele Ladder is needed to identify the PCR products (alleles) present in the evidence obtained from the crime scene.

4. What is required to visualize DNA following electrophoresis?

DNA is visualized by applying a stain to the gel. In this exercise, Fast Blast DNA stain is used, which turns DNA present in the gel an intense blue color.

Lesson Three: Drying Gels and Analysis of Results

3. **Does the Crime Scene DNA Sample have a genotype that matches any of the suspects? If so, which one matches?**

Yes; Suspect C should have the same genotype as the Crime Scene DNA sample.

4. **What does this result tell you about which suspects are included in the investigation? Excluded? Explain your answer.**

Suspect C is included as a suspect because Suspect C has the same genotype as a DNA sample found at the Crime Scene. Suspects A, B, + D are excluded as suspects because they do not have the same genotype as the DNA sample found at the Crime Scene.

5. **Imagine that each allele at the BXP007 locus is found at exactly the same frequency in a population. Since there are 8 possible alleles at the BXP007 locus, what is the frequency of any one allele from this locus in this population?**

If there are 8 alleles, and they are found at exactly the same frequency in a population, then the frequency of one allele would be 1/8.

6. **Given Mendel's Law of Independent Assortment and the assumption in question 5, what is the frequency of the genotype of the Crime Scene sample?**

The frequency of each allele is 1/8 given the assumption in question 5. The Law of Independent Assortment states that allele frequencies can be multiplied together to give a resulting genotype frequency at a single locus, so each allele frequency is multiplied together to give the genotype frequency - $1/8 \times 1/8 = 1/64$.

7. **If you had a pool of 13 suspects, and only one suspect had a genotype that matched the BXP007 locus found at the crime scene, would you be satisfied that you had identified the perpetrator based only on the genotype frequency calculated for the BXP007 locus? Why or why not? Explain your answer.**

If you had a pool of 13 suspects and only one of them had the same genotype at the BXP007 locus as found at the crime scene, you could be reasonably sure that you had your perpetrator, since you know that 1 out of 64 people are likely to have the same genotype as your suspect, and you're only examining 13 suspects. However, other evidence besides your genotype evidence would be needed to give you a stronger case, such as an eye witness, physical evidence left by the suspect at the scene of the crime, motive, etc.

Answers to Questions in Appendix C

Exercise I

Questions 1–4: In each question, another locus is added to the genotype. As a result, the number of siblings with the same genotype as the responding student should decrease with each question. The exact numbers of identical siblings and the specific pattern of decrease will differ from student to student and class to class, but the downward trend should be the same.

Question 5: How do your results demonstrate the principle of increasing power of discrimination used in forensic DNA profiling?

As the number of genetic loci increases, the number of included individuals decreases.

Question 6: If more than one child shared the same genotype, what possible explanations are there?

- *Identical twins*
- *Chance occurrence. With only 4 alleles this remains a possibility; as the number of loci increases, chance matches are less and less likely.*
- *Clones!?!?*

Exercise II

Question 1: What do you notice about allele frequencies between populations? Is there any specific trend?

Allele frequencies may be different between different ethnic populations. There are no specific trends.

Question 2: Forensic laboratory genotyping results often report random match probabilities for specific populations. Use the data in your chart to explain why this might be important. Hint: remember that the match probability is used to provide some indication about the "pool" of potential people with the same genotype as a suspect.

The random match probability may be different for different populations. Random match probability is most relevant for the same ethnic group as the individual under study, and it is important to know that the proper control group has been used for comparison.

Discussion questions:

1. **Imagine that blood, known to come from a criminal, was left at the scene of a crime, collected, and typed for the 13 CODIS loci. No suspect has been arrested, and there are no good investigative leads. Do you think that genotypes at the 13 CODIS loci should be used to make conclusions about the race of any potential suspect? Use what you have learned from the STRBase tables to support your position.**

Genotypes at the 13 CODIS loci should not be used to make any inferences about the race of a potential suspect because there are no alleles that uniquely identify any specific racial group.

2. What do you imagine are some of the difficulties in using population studies based on race?

Difficulties in using population studies based on race include:

- *Who identifies the race of a person? Most studies are self-identified by the individual and a person's ethnic identity may or may not accurately reflect biology or genetic history.*
- *How is racial identity determined for a person with mixed racial heritage?*
- *Even for an unambiguous racial assignment, there may still be some allele frequency differences between isolated geographical populations of origin. For example, for a Caucasian, populations of natives from northern Europe might have different allele frequencies from those from southern Europe.*

Appendix H

References, Recommended Web Sites, and Career Information

1. Benecke M, DNA typing in forensic medicine and in criminal investigations: a current survey, *Naturwissenschaften* 84, 181–188 (1997)
2. Butler JM, *Forensic DNA Typing*, Academic Press, San Diego (2001)
3. Butler JM et al., Allele frequencies for 15 autosomal STR loci on U.S. Caucasian, African American, and Hispanic populations, *J Forensic Sci.* 48, 908–911 (2003)
4. Byrd, M, DNA, The Next Generation Technology is Here, <http://www.crime-scene-investigator.net/dna.html>
5. Crime Scene Investigation (gateway site to information about crime scene investigation, education, jobs, and more), <http://www.crime-scene-investigator.net/>
6. DNA Typing and Identification, <http://faculty.ncwc.edu/toconnor/425/425lect15.htm>
7. ENFSI DNA WG STR Population Database, www.strbase.org
8. Leclair B et al., Kinship analysis and human identification in mass disasters: the use of MDKAP for the World Trade Center tragedy, *Genetic Identity Conference Proceedings: Thirteenth International Symposium on Human Identification* (2002)
9. OJ Simpson trial evidence, <http://www.law.umkc.edu/faculty/projects/ftrials/Simpson/Dna.htm>
10. Short tandem repeat DNA Internet database: Biology and Technology Behind STR Markers, <http://www.cstl.nist.gov/biotech/strbase/>
11. Strengths, Limitations and Controversies of DNA Testing, http://arbl.cvmb.colostate.edu/hbooks/genetics/medgen/dnatesting/dnatest_pcs.html
12. Thieman WJ and Palladino MA, Chapter 8: DNA fingerprinting and forensic analysis, pp 169–184 in *Introduction to Biotechnology*, Pearson/Benjamin Cummings, San Francisco (2004)
13. US Dept. of Justice, Federal Bureau of Investigation. The FBI's Combined DNA Index System Program (CODIS), <http://www.fbi.gov/hq/lab/codis>
14. Voter Information Guide. California Proposition 69: DNA Samples, <http://voterguide.ss.ca.gov/propositions/prop69-title.htm>

Careers in Forensic Sciences

Lorenz K, Think You Want to Be a CSI?

http://msn.careerbuilder.com/Custom/MSN/CareerAdvice/456.htm?siteid=cbm-snhm4441&sc_extcmp=JS_cj1_jan05_hotmail1>1=5938

US Department of Justice, Office of Justice Programs, National Institute of Justice, Education and Training in Forensic Science: A Guide for Forensic Science Laboratories, Educational Institutions, and Students, June 2004, <http://www.ojp.usdoj.gov/nij/pubs-sum/203099.htm>

Appendix I

Run Agarose DNA Gels in Under 20 Minutes

Bio-Rad's BioEducation R&D team has developed a new electrophoresis buffer formula. Using a reduced concentration of running buffer (0.25x TAE), and higher voltage (200 V), any agarose gel can be run 33% faster. Advantages of this new formula include:

- Excellent gel resolution
- Minimal run time
- Fast separation of DNA in gels of any agarose gel concentration (0.8–4.0%)
- Compatibility with all Bio-Rad Biotechnology Explorer program kits

TAE buffer is provided as a 50x concentrate that can be mixed with distilled water to yield the necessary concentrations for making agarose gels and electrophoresis running buffer.

Use 1x TAE to make agarose gels:

350 ml of 1x TAE is sufficient to pour eight 7 x 10 cm agarose gels. To make 350 ml of 1x TAE from a 50x TAE concentrate, add 7 ml of concentrate to 343 ml of distilled water. Detailed instructions for making agarose gels can be found in individual kit instruction manuals.

- Use 1x TAE to make 3% agarose gels for the Crime Scene Investigator PCR Basics™ kit
 - With the small DNA electrophoresis pack, dissolve 10.5 g of agarose in 350 ml of 1x TAE buffer, boil, and pour 40 ml per gel to make 8 handcast 3% agarose gels. Gels can be stored submerged in buffer for several weeks at 4°C
 - For added convenience, precast 3% agarose gels made with 1x TAE are available from Bio-Rad (catalog #161-3017EDU)

Use 0.25x TAE to make electrophoresis running buffer:

A 2.5 L volume of 0.25x TAE buffer is required to run eight 7 x 10 cm agarose gels. To make 2.5 L of 0.25x TAE from a 50x TAE concentrate, add 12.5 ml of concentrate to 2.49 L of distilled water. To make 2.5 L of 0.25x TAE from a 1x TAE solution, add 625 ml of 1x TAE to 1,875 ml of distilled water.

Note: Do not use 0.25x TAE to make agarose gels; doing so can lead to a loss of DNA resolution.

To run gels:

Place the gel in an electrophoresis chamber and cover it with 0.25x TAE; ensure the gel is submerged. Run gels at 200 V for no more than 20 min. Monitor gel loading dye progress to get a relative idea of electrophoresis progress.

Legal Notices

Notice regarding Bio-Rad thermal cyclers and real-time systems: Purchase of this instrument conveys a limited, non-transferable immunity from suit for the purchaser's own internal research and development and for use in applied fields other than Human In Vitro Diagnostics under one or more of U.S. Patents Nos. 5,656,493, 5,333,675, 5,475,610 (claims 1, 44, 158, 160–163, and 167 only), and 6,703,236 (claims 1–7 only), or corresponding claims in their non-U.S. counterparts, owned by Applied Biosystems. No right is conveyed expressly, by implication, or by estoppel under any other patent claim, such as claims to apparatus, reagents, kits, or methods such as 5' nuclease methods. Further information on purchasing licenses may be obtained by contacting the Director of Licensing, Applied Biosystems, 850 Lincoln Centre Drive, Foster City, California 94404, USA. Bio-Rad's real-time thermal cyclers are licensed real-time thermal cyclers under Applied Biosystems' United States Patent No. 6,814,934 B1 for use in research and for all other fields except the fields of human diagnostics and veterinary diagnostics. Purchase of iTaq™ DNA polymerase includes an immunity from suit under patents specified in the product insert to use only the amount purchased for the purchaser's own internal research. No other patent rights (such as 5' Nuclease Process patent rights) are conveyed expressly, by implication, or by estoppel. Further information on purchasing licenses may be obtained by contacting the Director of Licensing, Applied Biosystems, 850 Lincoln Centre Drive, Foster City, California 94404, USA

Trademarks

Tupperware is a registered trademark of Tupperware Worldwide.



**Bio-Rad
Laboratories, Inc.**

Life Science
Group

Web site www.bio-rad.com **USA** 800 4BIORAD **Australia** 61 02 9914 2800 **Austria** 01 877 89 01 **Belgium** 09 385 55 11 **Brazil** 55 21 3237 9400
Canada 905 364 3435 **China** 86 21 6426 0808 **Czech Republic** 420 241 430 532 **Denmark** 44 52 10 00 **Finland** 09 804 22 00 **France** 01 47 95 69 65
Germany 089 318 84 0 **Greece** 30 210 777 4396 **Hong Kong** 852 2789 3300 **Hungary** 36 1 455 8800 **India** 91 124 4029300 **Israel** 03 963 6050
Italy 39 02 216091 **Japan** 03 6361 7000 **Korea** 82 2 3473 4460 **Mexico** 52 555 488 7670 **The Netherlands** 0318 540666 **New Zealand** 0508 805 500
Norway 23 38 41 30 **Poland** 48 22 331 99 99 **Portugal** 351 21 472 7700 **Russia** 7 495 721 14 04 **Singapore** 65 6415 3188 **South Africa** 27 861 246 723
Spain 34 91 590 5200 **Sweden** 08 555 12700 **Switzerland** 061 717 95 55 **Taiwan** 886 2 2578 7189 **United Kingdom** 020 8328 2000